

311F L RR

Hydraulic Excavator

2017



Engine

Engine Model	Cat® C3.4B	
Engine Power – ISO 14396 (metric)	55 kW	74 hp
Net Power – ISO 9249 (metric)	52 kW	71 hp

Drive

Maximum Travel Speed	5.4 km/h
Maximum Drawbar Pull	114 kN

Weight

Minimum Operating Weight	12 400 kg
Maximum Operating Weight	13 900 kg

Introduction

Get your work done with a lot less fuel.

If you want a machine with the power to best fit your jobs but owning and operating costs to fit your business, then the Cat 311FL RR excavator is your answer. Its reduced radius will get you into some pretty tight spots, and its reasonable price and miserly fuel burn will help you operate on a tight budget.

The machine's C3.4B engine meets EU Stage IIIB emission standards and comes equipped with fuel savers like engine idle shutdown and eco mode to help you manage consumption. It also comes with an extremely quiet and comfortable cab to help you stay productive all day long.

Whether you are truck loading or stockpiling, trenching or digging, leveling or grading, you will be pleased with the reliable, fuel-saving performance you will get from the all-new Cat 311FL RR.

Contents

Reduced Radius	4
Engine	5
Hydraulics	6
Operator Station.....	8
Structures and Undercarriage	10
Front Linkage	11
Attachments.....	12
Integrated Technologies.....	14
Safety	15
Serviceability.....	16
Complete Customer Care.....	17
Sustainability	18
Specifications.....	19
Standard Equipment.....	31
Optional Equipment.....	32
Notes.....	33





The Cat 311F L RR delivers fuel savings and performance – two attributes you need to be successful in your business.

Reduced Radius

The right choice for your space-restricted work



Tight Job, Right Machine

With more and more jobs requiring work in tight spaces, a reduced radius machine is the right choice for you. The 311F L RR's tail swing radius is just 1750 mm. When rotated 90 degrees and working over the side, only 505 mm hangs over the side – ideal when you are working up against a wall, on a narrow road, or other space-restricted area.

Stable Platform

The 311F L RR offers a stable platform for all applications. One of the main contributors is the 2450 kg counterweight. This allows the shorter 311F L RR to perform like a longer tail swing machine.

Comfortable Full-Size Cab

While the length of the upper structure is reduced to accommodate the work at hand, the cab of the 311F L RR is not. It's the same size as our standard machines with all the amenities you've come to expect.

Engine

Powerful and fuel efficient to meet your expectations

A Unique Emissions Solution

The Cat C3.4B engine meets today's Stage IIIB emission standards. It provides plenty of power for the utility work you do and won't consume a lot of fuel to do it – all to help keep your owning and operating costs to an absolute minimum.

Fuel-Saving Features

One built-in fuel-saving feature is engine idle shutdown, which automatically turns the engine off when it's been idling for more than a specified amount of time. You can also choose eco mode to more actively manage fuel consumption for the job at hand. Both will help you save fuel, reduce emissions, and extend your service intervals.

Biodiesel Ready

The C3.4B engine can run on up to B20 biodiesel fuel that meets ASTM 6751 or EN 14214 standards – all to give you more potential fuel-saving flexibility.



Proven Technology

Every Stage IIIB engine is equipped with a combination of proven electronic, fuel, air, and aftertreatment components. Applying proven technologies lets us meet your high expectations for productivity, fuel efficiency, reliability, and service life. The right technologies fine-tuned for the right applications result in:

- **High performance** across a variety of applications
- **Maximized uptime and reduced cost** with world-class support from the Cat dealer network
- **Minimized impact** of emission systems – designed to be transparent to the operator without requiring interaction
- **Durable** designs with long life to overhaul
- **Better fuel economy** with minimized maintenance costs while providing the same great power and response

More Powerful, Reliable Engine Electronics

The electronics used in Cat Stage IIIB engines are more powerful and robust than ever. Enhanced features increase quality and reliability, which improves your owning and operating experience.

Next Generation Fuel Systems

As a key component of Cat Stage IIIB Technology, injection timing provides more control of combustion for the cleanest, most efficient fuel burn.

Innovative Air Management

Cat Stage IIIB engines feature innovative air-management systems that optimize airflow and enhance power, efficiency, and reliability. We apply a range of simple, reliable turbo charging solutions based on engine size and application. This allows us to match turbo performance to rated output for high productivity, excellent fuel efficiency, long life, and low operating costs for you.

Hydraulics

Made to move your material with precision



Efficient Design

Major hydraulic components like pumps and valves are located close together to make it possible to use shorter tubes and lines. This design leads to less friction loss in the lines, reduced pressure drops, and more power to the ground for the work you need to get done.

Control Like No Other

Controllability is one of the main attributes of Cat excavators, and one of the key contributors to this is the main control valve. The valve puts flow where you need it when you need it, which leads to smoother operation, greater efficiency, and lower fuel consumption.

Auxiliary Hydraulics for Added Versatility

This excavator is fitted with a sophisticated auxiliary hydraulic system that makes tool changes quick and easy. Simply select your hydraulic tool from the screen, and maximum flow and pressure will automatically be set so that tool usage is optimized and components are protected. Note that medium pressure flow used for tool rotation is provided by a stand-alone pump, and the benefit to you is that it does not affect multi-operation controllability. Finally, a universal quick coupler circuit can work with either high or medium pressure, allowing the machine to adapt to virtually any quick coupler in the market.

Electric Boom and Stick Regeneration for Added Efficiency

The 311FLRR regenerates the flow of oil from the head end of the boom cylinder to the rod end of the boom cylinder during the work cycle to save energy and improve fuel efficiency. It's optimized for any dial speed setting you select, which results in less pressure loss for higher controllability, more productivity, and lower operating costs. The machine also regenerates the flow of oil from the rod end of the stick cylinder to the head end of the stick cylinder during operation to increase speed.

Operator Station

Comfort and convenience to keep you productive



A Safe and Quiet Cab

The Roll-Over Protective Structure (ROPS) certified cab is not only a safety feature, but it is also a sound suppressor due to its special sealing and insulation. With the door and windows closed, you will experience a machine isolated from job site noises.

A Cool (and Warm) Environment

The automatic climate control system features multiple air outlets with filtered ventilation. Air flows on the floor, behind the seat, and in front of you to make your work in either hot or cold weather much more pleasant and productive.

Comfortable Seat Options

The seat range includes air suspension, heated, and air cooled options. Mechanical and air suspension seats include a reclining back, upper and lower slide adjustments, and height and tilt angle adjustments to meet your needs for maximum comfort.



Controls Just for You

The right and left joystick consoles can be adjusted to improve your comfort and productivity during the course of a day. Also, the right joystick features a button that will reduce engine speed when you are not working to help save fuel. Touch it once and speed reduces; touch it again and speed increases for normal operation.



An Easy-to-use Monitor

The LED monitor is easy to see and navigate. Programmable in up to 42 languages to meet today's diverse workforce, the monitor clearly displays critical information you need to operate efficiently. Plus it projects the image from the standard rearview camera to help you see what's going on around you so you can stay safely focused on the job.



Ample Storage and Auxiliary Power

Storage spaces are located in the front, rear, and side consoles of the cab. A drink holder accommodates a large mug with handle, and a shelf behind the seat stores large lunch or toolboxes. Power supply sockets are conveniently located near the key storage areas for charging your electronic devices like an MP3 player, a cell phone, or a tablet.

Structures and Undercarriage

Made to work in your tough utility applications

Robust Frames

The 311F L RR is a well-built machine that's designed to give you a long service life. The upper frame includes special mountings made specifically to support the heavy-duty cab; the lower frame is reinforced to enhance component durability so you can count on the machine doing the work you need done.

Durable Undercarriage

Long undercarriage is standard and works extremely well in various work applications and conditions. Track shoes, links, rollers, idlers, and final drives are all built with high tensile-strength steel for long-term durability.



Great Weight

The pressed 2450 kg counterweight provides plenty of balance for your heavy lifting operations. It also has an integrated housing to protect the standard rearview camera.



Front Linkage

Take on your far-reaching or up-close tasks

Booms and Sticks

The 311F L RR is offered with a 4.3 m reach boom and two stick configurations: an R2.8m and an R2.25m. The reach boom offers you excellent all-around versatility and a large working envelope. The longer stick is best for when you need deep trenching, longer reach, and top truck loading capabilities. The shorter stick provides greater breakout force and increases productivity when you primarily plan on using hydro mechanical work tools.

Built to Last

All Cat booms and sticks are built with internal baffle plates for added durability, and all undergo ultrasound inspection to ensure weld quality and reliability. Large box-section structures with thick multi-plate fabrications, castings, and forgings are used in high-stress areas such as the boom nose, boom foot, boom cylinder, and stick foot to improve durability. Also, the front linkage pins' inner bearing surfaces are welded with a self-lubricated bearing used to extend service intervals and increase uptime.



Attachments

Tools to make you productive and profitable



The 311F L RR is a highly versatile machine that packs a lot of performance into a small package. You can easily expand that performance by utilizing any of the variety of attachments offered by Cat Work Tools.

Change Jobs Quickly

A quick coupler brings the ability to quickly change attachments and switch from job to job.

Dig, Finish and Compact

A wide range of buckets dig everything from top soil to highly abrasive material. For finishing and grading work, compact and shallow ditch cleaning buckets fit the need. A Cat compactor prepares the area for the next phase of construction.

Break, Demolish and Scrap

A hydraulic hammer equips the 311F L RR for breaking sidewalks, driveways, and pavement. A shear allows you to cut metal down to size for recycling or transport.

Move and Handle All Sorts of Material

When your job requires constant material handling, a grapple may be your solution. Choose from three different grapple styles for loading, sorting and picking trash, demolition debris, or recyclables.

Set Up Your Machine for Maximum Profitability

Your Cat dealer can install hydraulic kits to properly operate all Cat Work Tool attachments – maximizing the machine's uptime and your profits.

SWAP TOOLS



Universal Quick Coupler

GRAB, SORT, LOAD



GSH Orange Peel Grapples



GSM Orange Peel Grapples

DIG



Tilt Buckets



Ditch Cleaning Buckets

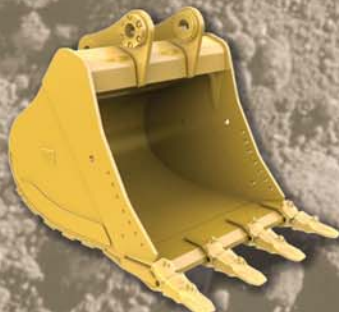

General Duty Buckets

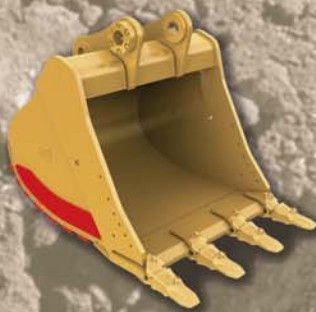

Heavy Duty Buckets



Severe Duty Buckets

PACK



Vibratory Plate Compactors

CUT, CRUSH, BREAK & RIP



Scrap & Demolition Shears



Hydraulic Hammers



Rippers

Integrated Technologies

Monitor, Manage, and Enhance Job Site Operations

Cat Connect makes smart use of technology and services to improve your job site efficiency. Using the data from technology-equipped machines, you'll get more information and insight into your equipment and operations than ever before.

Cat Connect technologies offers improvements in these key areas:



EQUIPMENT
MANAGEMENT

Equipment Management – increase uptime and reduce operating costs.



PRODUCTIVITY

Productivity – monitor production and manage job site efficiency.



SAFETY

Safety – enhance job site awareness to keep your people and equipment safe.

Featured Cat Connect technologies include:



LINK

Link

Link technologies provide wireless capability to machines enabling two-way transfer of information collected by on-board sensors, control modules, and other Cat Connect technologies using off-board apps, such as our VisionLink® software.

Manage Your Machine Remotely

Cat Product Link™ is an optional system that is deeply integrated into the machine monitoring system to take the guesswork out of managing your equipment. The system tracks location, hours, fuel usage, productivity, idle time, and diagnostic codes through the online VisionLink interface to help you maximize efficiency, improve productivity, and lower operating costs. Manage the data yourself or get expert advice from your Cat dealer to keep your equipment operating at peak performance.

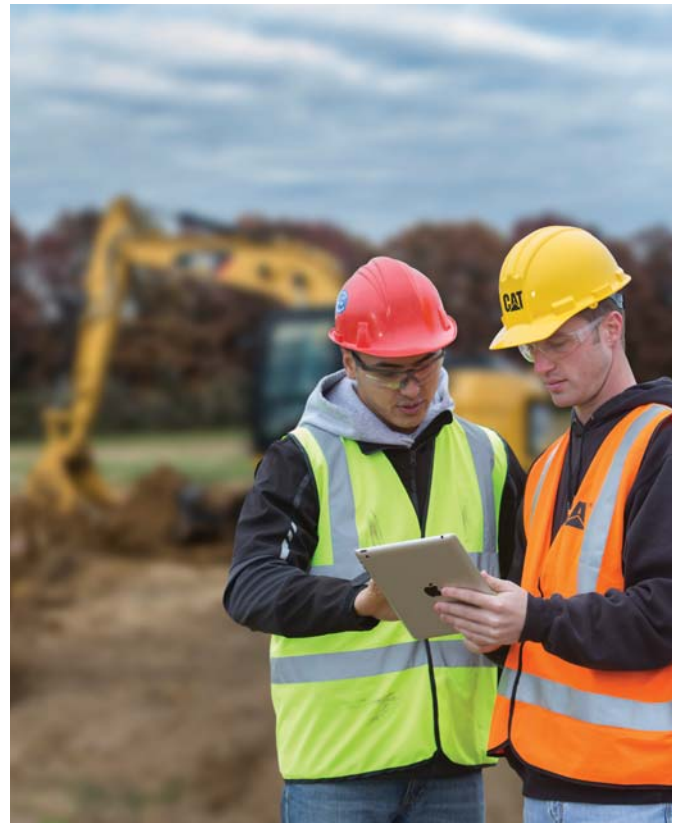

CAT CONNECT



EQUIPMENT
MANAGEMENT



PRODUCTIVITY



SAFETY



SUSTAINABILITY

Safety

Features to help protect you day in and day out



A Safe and Quiet Cab

You will benefit from the enhanced protection of a ROPS-certified cab. Not only is it safe, but its special roof lining and sealing make the sound inside comparable to any of today's on-highway trucks.

Secure Contact Points

Your slipping hazards are reduced with anti-skid plates on the surface of the upper structure and the top of the storage box area. The plates are effective in all types of weather conditions, and they can be removed for cleaning. Large steps as well as hand rails allow you to confidently and safely work with the machine. Steps on the track frame will get you into the cab as well as a leg up to the compartments. Extended hand rails allow you to safely climb to the upper deck. An additional hand rail above the air cleaner compartment gives you a holding point while standing on the track.



Great Visibility

Ample glass gives you excellent visibility out front and to the side, and the standard rear and side view camera gives you a clear field of view behind the machine through the cab monitor. The available 70/30 split-configuration windshield features an upper window with handles that make it easy to slide and store above you and a lower window that can be removed and stored on the inside wall of the cab. The large skylight provides you with enhanced visibility and also serves as an emergency exit. Halogen lights provide plenty of illumination and can be programmed to stay on for up to 90 seconds after the engine has been turned off to help you safely exit the machine.

A Worthwhile Guard Option

Optional FOGS (Falling Object Guards Systems) protect your operator and cab windows from debris damage, enhancing safety. It consists of two separate top and front guards. The front guard is easily opened to facilitate regular cleaning of the cab windshield.



Serviceability

Designed to make your maintenance quick and easy

Ground-Level Access Built In

You can easily reach most routine maintenance items like fuel and oil filters, fluid taps, and grease points from the safety and convenience of ground level. Not only do compartments feature wide service doors designed to help prevent debris entry, but they also securely latch in place to help make your service work simpler.

A Cool Design

The unique cooling package includes a screen between the radiator and AC condenser to prevent plugging. In addition, wider clearance is provided between the radiator and A/C condenser to help make blowing off debris easy for you, which can help improve your machine's reliability and performance in high ambient conditions.

A Fresh Idea

When you select ventilation inside the cab, outside air enters through the fresh air filter. The filter is conveniently located on the side of the cab to make it easy to reach and replace, and it is protected by a lockable door that can be opened with the engine key.

Other Service Benefits

The fuel tank's drain cock makes it easy and simple for you to remove water and sediment during routine maintenance. Plus an integrated fuel level indicator pops up to help you reduce the possibility of fuel tank overfilling.

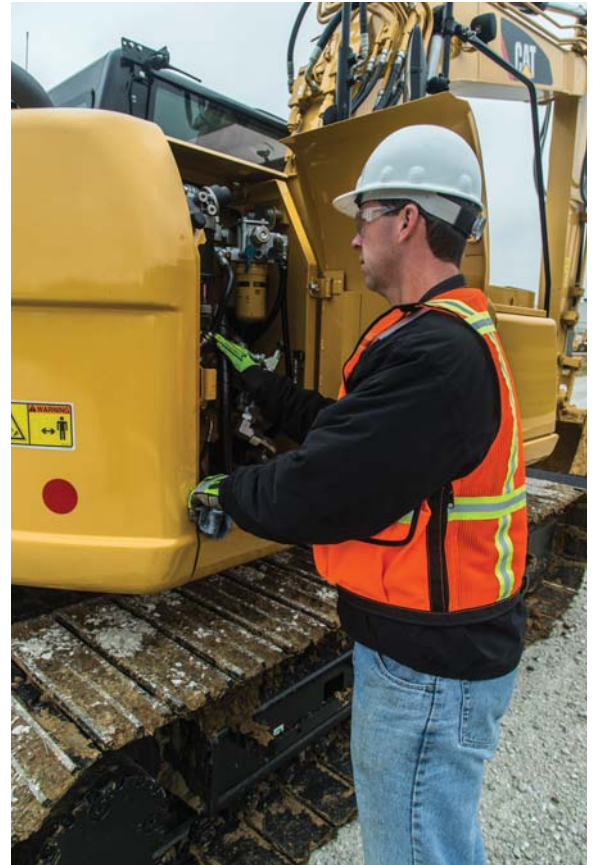



Complete Customer Care

Support you can count on

Worldwide Parts Availability

Cat dealers utilize a worldwide parts network to maximize your machines' uptime. Plus they can help you save money with Cat remanufactured components.

Advice You Can Trust

What are the job requirements and machine attachments? What production is needed? Your Cat dealer can provide recommendations to help you make the right machine choices.

Financial Options Just for You

Consider financing options and day-to-day operating costs. Look at dealer services that can be included in the machine's cost to yield lower owning and operating costs over time.

Support Agreements to Fit Your Needs

Cat dealers offer a variety of customer support agreements and work with you to develop a plan to meet your specific needs. These plans can cover the entire machine, including attachments, to help protect your investment.

Operating Techniques to Boost Your Profits

Improving operating techniques can boost your profits. Your Cat dealer has videos, literature, and other ideas to help you increase productivity. Caterpillar also offers simulators and certified operator training to help maximize the return on your investment.

What's Best for You Today...and Tomorrow

Repair, rebuild, or replace? Your Cat dealer can help you evaluate the cost involved so you can make the best choice for your business.



Sustainability

Generations ahead in every way

- The C3.4B engine meets Stage IIIB emission standards.
- The 311F L RR performs a similar amount of work while burning less fuel than the previous D Series model. This means more efficiency, less resources consumed, and fewer emissions.
- The 311F L RR has the flexibility of running on either ultra-low-sulfur diesel (ULSD) fuel with 10 ppm of sulfur or less or biodiesel (up to B20) fuel blended with ULSD that meets ASTM 6751 or EN14214 standards.
- An overfill indicator rises when the fuel tank is full to help service technicians avoid spilling.
- The 311F L RR is built to be rebuilt with major structures and components capable of being remanufactured to reduce waste and replacement costs.
- The 311F L RR is an efficient, productive machine that's designed to conserve our natural resources for the generations ahead.

311F L RR Hydraulic Excavator Specifications

Engine

Engine Power – ISO 14396 (metric)	55 kW	74 hp
Net Power – ISO 9249 (metric)	52 kW	71 hp
Bore	99 mm	
Stroke	110 mm	
Displacement	3.4 L	

Hydraulic System

Main System – Maximum Flow (total)	125 × 2 L/min
Maximum Pressure – Equipment	30.5 MPa
Maximum Pressure – Travel	35 MPa
Maximum Pressure – Swing	23 MPa
Pilot System – Maximum Flow	21.9 L/min
Pilot System – Maximum Pressure	4120 kPa
Boom Cylinder – Bore	100 mm
Boom Cylinder – Stroke	1002 mm
Stick Cylinder – Bore	110 mm
Stick Cylinder – Stroke	1194 mm
Bucket Cylinder – Bore	100 mm
Bucket Cylinder – Stroke	939 mm

Drive

Maximum Travel Speed – High	5.4 km/h
Maximum Travel Speed – Low	3.6 km/h
Maximum Drawbar Pull	114.3 kN

Swing

Swing Speed	10 rpm
Swing Torque	30.9 kN·m

Service Refill Capacities

Fuel Tank Capacity	210 L
Cooling System	18 L
Engine Oil (with filter)	8 L
Swing Drive (each)	3 L
Final Drive (each)	3 L
Hydraulic System Oil (including tank)	160 L
Hydraulic Tank Oil	95 L

Track

Number of Shoes (each side)	43 pieces
Number of Track Rollers (each side)	6 pieces
Number of Carrier Rollers (each side)	1 piece

Sound

Operator Sound Pressure Level (ISO 6396:2008)	72 dB(A)
Exterior Sound Power Level (ISO 6395:2008)*	99 dB(A)

*European Union Directive “2000/14/EC” as amended by “2005/88/EC,” with the cooling fan speed set at 70% of maximum value.

The sound values indicated above are for specific operating conditions only. Machine and operator sound levels will vary at different engine and/or cooling fan speeds. Hearing protection may be needed when the machine is operated with a cabin that is not properly maintained, or when the doors and/or windows are open for extended periods or in a noisy environment.

Air Conditioning System

The air conditioning system on this machine contains the fluorinated greenhouse gas refrigerant R134a (Global Warming Potential = 1430). The system contains 0.90 kg of refrigerant which has a CO₂ equivalent 1.287 metric tonne.

311F L RR Hydraulic Excavator Specifications

Dimensions

All dimensions are approximate and may vary depending on bucket selection.

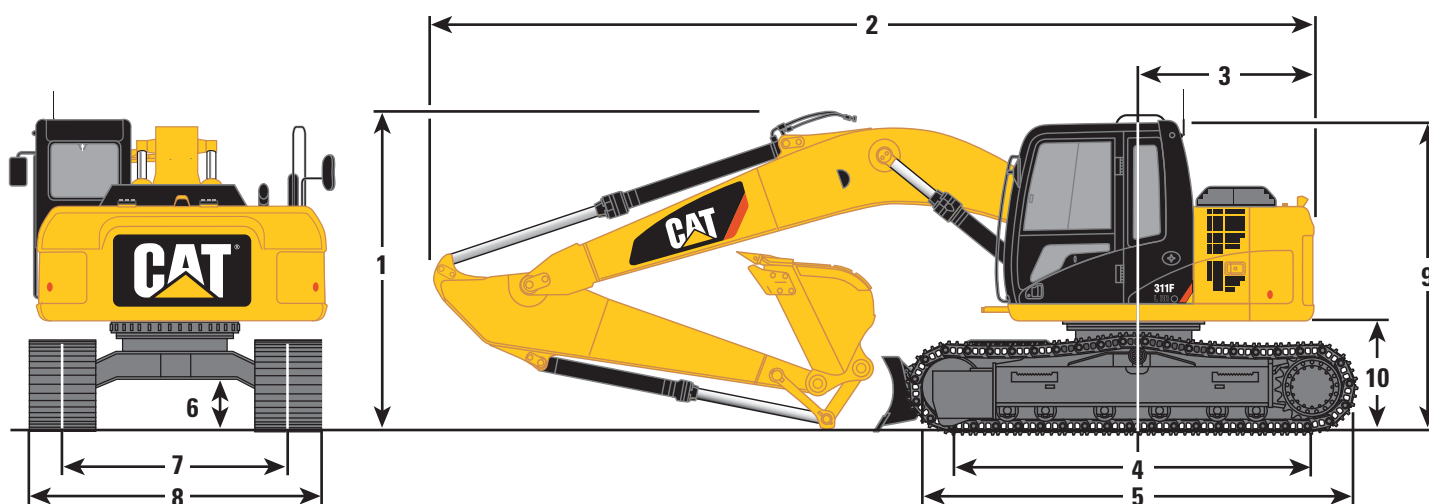

Stick	Reach Boom 4.3 m	
	R2.8	R2.25
1 Shipping Height*	2820 mm	2860 mm
Shipping Height at Boom Top	2760 mm	2860 mm
Shipping Height at Handrail	2820 mm	2820 mm
2 Shipping Length		
Without Blade	6910 mm	6920 mm
With Blade	7530 mm	7540 mm
3 Tail Swing Radius	1750 mm	1750 mm
4 Length to Center of Rollers	2780 mm	2780 mm
5 Track Length	3490 mm	3490 mm
6 Ground Clearance	440 mm	440 mm
7 Track Gauge	1990 mm	1990 mm
8 Transport Width		
500 mm Shoes	2490 mm	2490 mm
600 mm Shoes	2590 mm	2590 mm
700 mm Shoes	2690 mm	2690 mm
770 mm Shoes	2760 mm	2760 mm
9 Cab Height	2760 mm	2760 mm
Cab Height with Top Guard	2900 mm	2900 mm
10 Counterweight Clearance**	910 mm	910 mm
Bucket Type	GD	GD
Bucket Capacity	0.53 m ³	0.53 m ³
Bucket Tip Radius	1230 mm	1230 mm

Notes: All dimensions based on bucket A (see table)

*Including shoe lug height.

**Without shoe lug height.

311F L RR Hydraulic Excavator Specifications

Working Ranges

All dimensions are approximate and may vary depending on bucket selection.

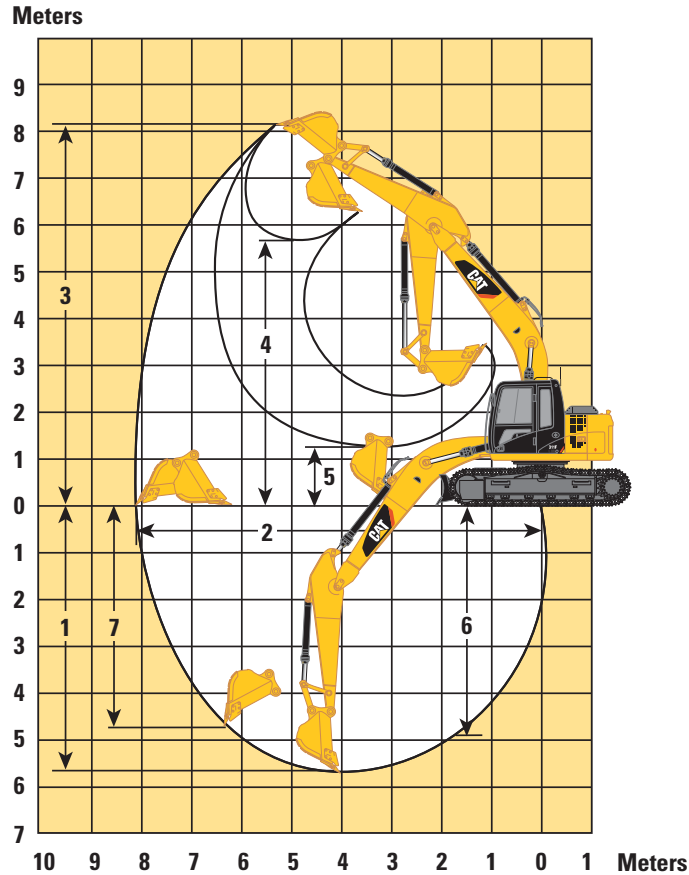

Stick	Reach Boom 4.3 m	
	R2.8	R2.25
1 Maximum Digging Depth	5590 mm	5040 mm
2 Maximum Reach at Ground Level	8100 mm	7570 mm
3 Maximum Cutting Height	8140 mm	7820 mm
4 Maximum Loading Height	5770 mm	5440 mm
5 Minimum Loading Height	1330 mm	1870 mm
6 Maximum Depth Cut for 2440 mm Level Bottom	4990 mm	4330 mm
7 Maximum Vertical Wall Digging Depth	4880 mm	4360 mm
Bucket Type	GD	GD
Bucket Capacity	0.53 m ³	0.53 m ³
Bucket Tip Radius	1230 mm	1230 mm

311F L RR Hydraulic Excavator Specifications

Blade

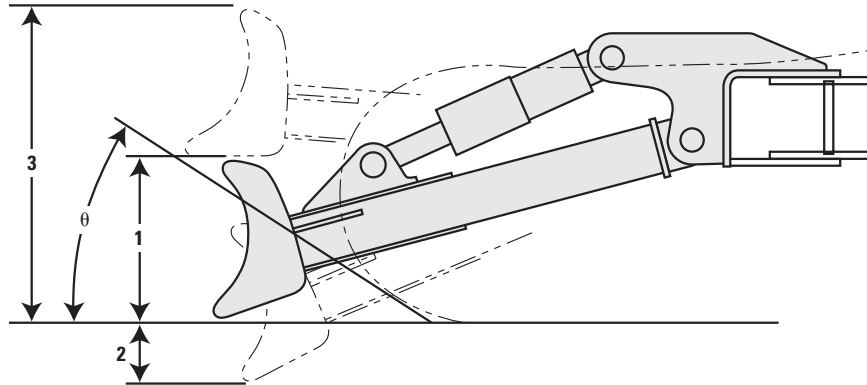

Blade Options	2500 mm	2600 mm	2700 mm
Recommended Track Shoe Width	500 mm	600 mm	700 mm
1 Blade Height		630 mm	
2 Maximum Lowering Depth from Ground		570 mm	
3 Maximum Raising Height above Ground		1000 mm	
Approach Angle		23 degrees	

311F L RR Hydraulic Excavator Specifications

Major Component Weights

Base Machine (with boom cylinder, without counterweight, front linkage and track)	4050 kg
Long Undercarriage	2430 kg
Counterweight	2450 kg
Boom (includes lines, pins and stick cylinder)	
Reach Boom (4.3 m)	930 kg
Stick (includes lines, pins and bucket cylinder)	
R2.8	610 kg
R2.25	530 kg
Track Shoe (per two track)	
500 mm Triple Grouser	1460 kg
600 mm Triple Grouser	1700 kg
700 mm Triple Grouser	1960 kg
770 mm Triple Grouser	2100 kg
Blade	
2500 mm	810 kg
2600 mm	810 kg
2700 mm	820 kg
Bucket	
0.53 m ³ – 1200 mm	460 kg

All weights are rounded up to nearest 10 kg except for bucket.

Base machine includes 75 kg operator weight and 90% fuel weight.

Operating Weights and Ground Pressures

	770 mm Triple Grouser Shoes		700 mm Triple Grouser Shoes		600 mm Triple Grouser Shoes		500 mm Triple Grouser Shoes	
	kg	kPa	kg	kPa	kg	kPa	kg	kPa
Without Blade								
Reach Boom (4.65 m)								
R2.8	13 100	27.5	12 900	29.8	12 700	34.2	12 500	40.4
R2.25	13 000	27.3	12 900	29.8	12 600	34.0	12 400	40.1
With Blade								
Reach Boom (4.65 m)								
R2.8	13 900	29.2	13 800	31.9	13 500	36.4	13 300	43.0
R2.25	13 800	29.0	13 700	31.7	13 400	36.1	13 200	42.7

All weights are rounded up to nearest 10 kg except for bucket.

Base machine includes 75 kg operator weight and 90% fuel weight.

311F L RR Hydraulic Excavator Specifications

Bucket and Stick Forces

	Reach Boom 4.3 m	
	R2.8	R2.25
Pin On		
General Duty – 0.53 m³		
Bucket Digging Force (ISO)	89 kN	89 kN
Stick Digging Force (ISO)	52 kN	60 kN
Heavy Duty – 0.76 m³		
Bucket Digging Force (ISO)	89 kN	89 kN
Stick Digging Force (ISO)	52 kN	60 kN
Severe Duty – 0.53 m³		
Bucket Digging Force (ISO)	89 kN	89 kN
Stick Digging Force (ISO)	52 kN	60 kN
With CW-20		
General Duty – 0.76 m³		
Bucket Digging Force (ISO)	77 kN	77 kN
Stick Digging Force (ISO)	50 kN	57 kN
Heavy Duty – 0.76 m³		
Bucket Digging Force (ISO)	77 kN	77 kN
Stick Digging Force (ISO)	50 kN	57 kN
With CW-20S		
General Duty – 0.76 m³		
Bucket Digging Force (ISO)	77 kN	77 kN
Stick Digging Force (ISO)	50 kN	57 kN
Heavy Duty – 0.76 m³		
Bucket Digging Force (ISO)	77 kN	77 kN
Stick Digging Force (ISO)	50 kN	57 kN

311F L RR Hydraulic Excavator Specifications

Reach Boom Lift Capacities – Counterweight: 2450 kg – without Bucket

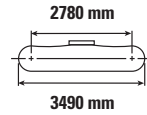
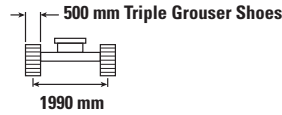
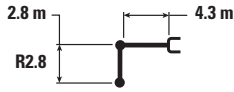

		1500 mm		3000 mm		4500 mm		6000 mm		mm		
											mm	
6000 mm	kg									*1650	*1650	5280
4500 mm	kg							*2300	2050	*1500	*1500	6290
3000 mm	kg					*3250	3150	2800	2000	*1450	*1450	6830
1500 mm	kg			*6100	5350	*4100	2900	2750	1900	*1550	1500	7010
0 mm	kg			*7500	4950	4050	2750	2650	1850	*1700	1500	6850
-1500 mm	kg	*4800	*4800	*7650	4850	3950	2650	2600	1800	*2050	1650	6350
-3000 mm	kg	*7950	*7950	*6850	4900	3950	2650			*2850	2100	5380

Reach Boom Lift Capacities – Counterweight: 2450 kg – without Bucket

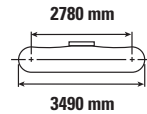
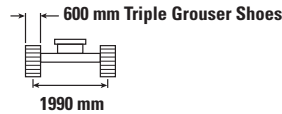
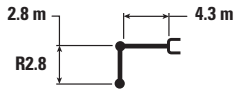

		1500 mm		3000 mm		4500 mm		6000 mm		mm		
											mm	
6000 mm	kg									*1650	*1650	5280
4500 mm	kg							*2300	2100	*1500	*1500	6290
3000 mm	kg					*3250	3200	2900	2050	*1450	*1450	6830
1500 mm	kg			*6100	5450	*4100	3000	2800	1950	*1550	*1550	7010
0 mm	kg			*7500	5050	4100	2800	2700	1850	*1700	1550	6850
-1500 mm	kg	*4800	*4800	*7650	4950	4050	2700	2650	1850	*2050	1700	6350
-3000 mm	kg	*7950	*7950	*6850	5000	4050	2700			*2850	2150	5380



ISO 10567



* Indicates that the load is limited by hydraulic lifting capacity rather than tipping load. The above loads are in compliance with hydraulic excavator lift capacity standard ISO 10567:2007. They do not exceed 87% of hydraulic lifting capacity or 75% of tipping load. Weight of all lifting accessories must be deducted from the above lifting capacities. Lifting capacities are based on the machine standing on a firm, uniform supporting surface. The use of a work tool attachment point to handle/lift objects, could affect the machine lift performance.

Lift capacity stays with ±5% for all available track shoes.

Always refer to the appropriate Operation and Maintenance Manual for specific product information.

311F L RR Hydraulic Excavator Specifications

Reach Boom Lift Capacities – Counterweight: 2450 kg – without Bucket

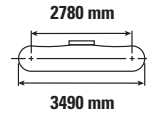
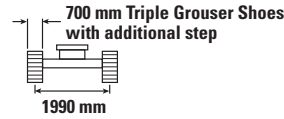
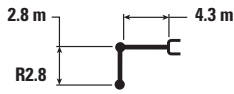

		1500 mm		3000 mm		4500 mm		6000 mm		mm		
6000 mm	kg									*1650	*1650	5280
4500 mm	kg							*2300	2100	*1500	*1500	6290
3000 mm	kg					*3250	3250	2950	2050	*1450	*1450	6830
1500 mm	kg			*6100	5550	*4100	3050	2850	2000	*1550	*1550	7010
0 mm	kg			*7500	5150	4200	2850	2750	1900	*1700	1600	6850
-1500 mm	kg	*4800	*4800	*7650	5050	4100	2750	2700	1850	*2050	1750	6350
-3000 mm	kg	*7950	*7950	*6850	5100	4150	2800			*2850	2200	5380

Reach Boom Lift Capacities – Counterweight: 2450 kg – without Bucket

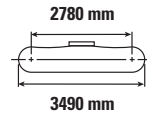
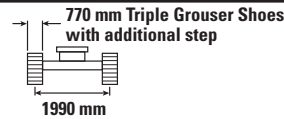
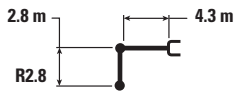

		1500 mm		3000 mm		4500 mm		6000 mm		mm		
6000 mm	kg									*1650	*1650	5280
4500 mm	kg							*2300	2150	*1500	*1500	6290
3000 mm	kg					*3250	*3250	2950	2100	*1450	*1450	6830
1500 mm	kg			*6100	5650	*4100	3050	2850	2000	*1550	*1550	7010
0 mm	kg			*7500	5200	4250	2900	2800	1950	*1700	1600	6850
-1500 mm	kg	*4800	*4800	*7650	5100	4150	2800	2750	1900	*2050	1750	6350
-3000 mm	kg	*7950	*7950	*6850	5150	4200	2800			*2850	2250	5380



ISO 10567



* Indicates that the load is limited by hydraulic lifting capacity rather than tipping load. The above loads are in compliance with hydraulic excavator lift capacity standard ISO 10567:2007. They do not exceed 87% of hydraulic lifting capacity or 75% of tipping load. Weight of all lifting accessories must be deducted from the above lifting capacities. Lifting capacities are based on the machine standing on a firm, uniform supporting surface. The use of a work tool attachment point to handle/lift objects, could affect the machine lift performance.

Lift capacity stays with $\pm 5\%$ for all available track shoes.

Always refer to the appropriate Operation and Maintenance Manual for specific product information.

311F L RR Hydraulic Excavator Specifications

Reach Boom Lift Capacities – Counterweight: 2450 kg – without Bucket

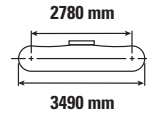
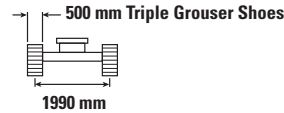
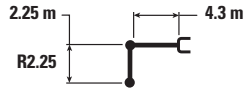

		1500 mm		3000 mm		4500 mm		6000 mm		mm		
6000 mm	kg					*2350	*2350			*2100	*2100	4560
4500 mm	kg					*3150	*3150			*1900	*1900	5700
3000 mm	kg			*4800	*4800	*3700	3100	2800	2000	*1850	1850	6290
1500 mm	kg			*6900	5250	4200	2900	2750	1900	*1950	1700	6480
0 mm	kg			*7750	4950	4050	2750	2650	1850	*2200	1750	6320
-1500 mm	kg	*5550	*5550	*7500	4950	4000	2700			*2750	1950	5760
-3000 mm	kg	*9950	*9950	*6250	5050	*4050	2750			*3800	2650	4680

Reach Boom Lift Capacities – Counterweight: 2450 kg – without Bucket

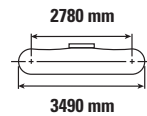
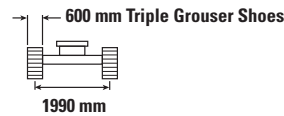
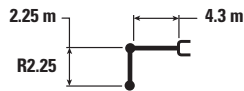

		1500 mm		3000 mm		4500 mm		6000 mm		mm		
6000 mm	kg					*2350	*2350			*2100	*2100	4560
4500 mm	kg					*3150	*3150			*1900	*1900	5700
3000 mm	kg			*4800	*4800	*3700	3150	2850	2000	*1850	*1850	6290
1500 mm	kg			*6900	5350	4300	2950	2800	1950	*1950	1750	6480
0 mm	kg			*7750	5050	4150	2800	2700	1900	*2200	1750	6320
-1500 mm	kg	*5550	*5550	*7500	5000	4100	2750			*2750	2000	5760
-3000 mm	kg	*9950	*9950	*6250	5100	*4050	2850			*3800	2700	4680



ISO 10567



* Indicates that the load is limited by hydraulic lifting capacity rather than tipping load. The above loads are in compliance with hydraulic excavator lift capacity standard ISO 10567:2007. They do not exceed 87% of hydraulic lifting capacity or 75% of tipping load. Weight of all lifting accessories must be deducted from the above lifting capacities. Lifting capacities are based on the machine standing on a firm, uniform supporting surface. The use of a work tool attachment point to handle/lift objects, could affect the machine lift performance.









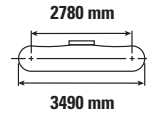
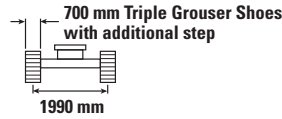
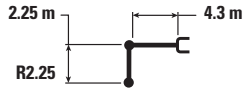

Lift capacity stays with ±5% for all available track shoes.

Always refer to the appropriate Operation and Maintenance Manual for specific product information.

311F L RR Hydraulic Excavator Specifications









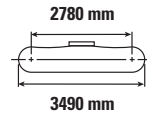
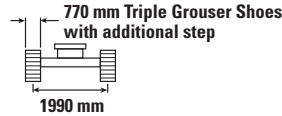
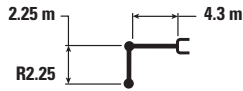

Reach Boom Lift Capacities – Counterweight: 2450 kg – without Bucket



		1500 mm		3000 mm		4500 mm		6000 mm				
												mm
6000 mm	kg					*2350	*2350			*2100	*2100	4560
4500 mm	kg					*3150	*3150			*1900	*1900	5700
3000 mm	kg			*4800	*4800	*3700	3200	2900	2050	*1850	*1850	6290
1500 mm	kg			*6900	5450	4400	3000	2850	2000	*1950	1800	6480
0 mm	kg			*7750	5150	4200	2850	2800	1950	*2200	1800	6320
-1500 mm	kg	*5550	*5550	*7500	5150	4150	2800			*2750	2050	5760
-3000 mm	kg	*9950	*9950	*6250	5250	*4050	2900			*3800	2750	4680

Reach Boom Lift Capacities – Counterweight: 2450 kg – without Bucket



		1500 mm		3000 mm		4500 mm		6000 mm				
												mm
6000 mm	kg					*2350	*2350			*2100	*2100	4560
4500 mm	kg					*3150	*3150			*1900	*1900	5700
3000 mm	kg			*4800	*4800	*3700	3250	2950	2100	*1850	*1850	6290
1500 mm	kg			*6900	5500	4450	3050	2900	2000	*1950	1800	6480
0 mm	kg			*7750	5200	4250	2900	2800	1950	*2200	1850	6320
-1500 mm	kg	*5550	*5550	*7500	5200	4200	2850			*2750	2050	5760
-3000 mm	kg	*9950	*9950	*6250	5300	*4050	2900			*3800	2800	4680



ISO 10567



* Indicates that the load is limited by hydraulic lifting capacity rather than tipping load. The above loads are in compliance with hydraulic excavator lift capacity standard ISO 10567:2007. They do not exceed 87% of hydraulic lifting capacity or 75% of tipping load. Weight of all lifting accessories must be deducted from the above lifting capacities. Lifting capacities are based on the machine standing on a firm, uniform supporting surface. The use of a work tool attachment point to handle/lift objects, could affect the machine lift performance.

Lift capacity stays with $\pm 5\%$ for all available track shoes.

Always refer to the appropriate Operation and Maintenance Manual for specific product information.

311F L RR Hydraulic Excavator Specifications

Work Tool Offering Guide*

Boom Type	Reach Boom	
Stick Size	R2.8	R2.25
Hydraulic Hammer	H95Es H110Es**	H95Es H110Es
Demolition and Sorting Grapple	NA	G310B**
Mobile Scrap and Demolition Shear	S320B (stick mounted)	S320B (stick mounted)
Compactor (Vibratory Plate)	CVP75	CVP75
Orange Peel Grapple GSM and GSH	These work tools are available for the 311F L RR.	
CW Quick Coupler	Consult your Cat dealer for proper match.	

*Offerings not available in all areas. Maximum weight limitation for ROPS certification is (14 712 kg). Matches are dependent on excavator configurations. Consult your Cat dealer to determine what is offered in your area, and, for proper work tool match.

**Pin on only.

311F L RR Hydraulic Excavator Specifications

Bucket Specifications and Compatibility

	Width	Capacity	Weight	Fill	Reach Booms – No Blade Installed								Reach Booms – Blade Installed							
					500 mm TG		600 mm TG		700 mm TG		770 mm TG		500 mm TG		600 mm TG		700 mm TG		770 mm TG	
					2.25	2.8	2.25	2.8	2.25	2.8	2.25	2.8	2.25	2.8	2.25	2.8	2.25	2.8	2.25	2.8
mm	m ³	kg	%																	
Without Quick Coupler																				
General Duty (GD)	600	0.31	315	100	●	●	●	●	●	●	●	●	●	●	●	●	●	●		
	750	0.41	362	100	●	●	●	●	●	●	●	●	●	●	●	●	●	●		
	900	0.53	411	100	●	●	●	●	●	●	●	●	●	●	●	●	●	●		
	1000	0.60	436	100	●	⊙	●	⊙	●	⊙	●	●	●	●	●	●	●	●		
	1100	0.68	470	100	⊙*	⊖*	●*	⊖*	●*	⊖*	●*	⊙*	●*	⊙*	●*	⊙*#	●*#	⊙*#	●*#	
	1200	0.76	499	100	⊖*	○*	⊙*	○*	⊙*	⊖*	⊙*	⊖*	⊙*	⊖*	⊙*	⊖*#	⊙*#	⊖*#	⊙*#	
Heavy Duty (HD)	450	0.20	276	100	●	●	●	●	●	●	●	●	●	●	●	●	●	●		
	1200	0.76	506	100	⊖*	○*	⊙*	○*	⊙*	⊖*	⊙*	⊖*	⊙*	⊖*	⊙*	⊖*#	⊙*#	⊖*#	⊙*#	
Maximum load pin on (payload + bucket)				kg	1794	1538	1833	1574	1876	1612	1899	1634	1924	1656	1965	1693	2009	1734	2033	1755

	Width	Capacity	Weight	Fill	Reach Booms – No Blade Installed								Reach Booms – Blade Installed							
					500 mm TG		600 mm TG		700 mm TG		770 mm TG		500 mm TG		600 mm TG		700 mm TG		770 mm TG	
					2.25	2.8	2.25	2.8	2.25	2.8	2.25	2.8	2.25	2.8	2.25	2.8	2.25	2.8	2.25	2.8
mm	m ³	kg	%																	
With Quick Coupler (CW20/CW20s)																				
General Duty (GD)	450	0.20	300	100	●	●	●	●	●	●	●	●	●	●	●	●	●	●		
	500	0.24	309	100	●	●	●	●	●	●	●	●	●	●	●	●	●	●		
	600	0.31	328	100	●	●	●	●	●	●	●	●	●	●	●	●	●	●		
	750	0.41	374	100	●	●	●	●	●	●	●	●	●	●	●	●	●	●		
	900	0.53	423	100	●	⊖	●	⊙	●	⊙	●	⊙	●	⊙	●	⊙	●	⊙	●	
	1000	0.60	452	100	⊙	⊖	⊙	⊖	●	⊖	●	⊖	●	⊖	●	⊙	⊙	●	⊙	
	1100	0.68	482	100	⊖	○	⊖	○	⊙	○	⊙	○	⊙	○	⊙	⊖	⊙	⊖	⊙	
	1200	0.76	511	100	○*	◇*	⊖*	◇*	⊖*	○*	⊖*	○*	⊖*	○*	⊖*	○*#	⊙*#	⊖*#	○*#	
Heavy Duty (HD)	500	0.24	319	100	●	●	●	●	●	●	●	●	●	●	●	●	●	●		
	1200	0.76	511	100	○*	◇*	⊖*	◇*	⊖*	○*	⊖*	○*	⊖*	○*	⊖*#	⊙*#	⊖*#	○*#		
Maximum load pin on (payload + bucket)				kg	1583	1327	1622	1363	1665	1401	1688	1423	1713	1445	1754	1482	1798	1523	1822	1544

The above loads are in compliance with hydraulic excavator standard EN474, they do not exceed 87% of hydraulic lifting capacity or 75% of tipping capacity with front linkage fully extended at ground line with bucket curled.

Capacity based on ISO 7451.
Bucket weight with long tips.

*For General Duty applications.

#Consult dealer for maximum weight limitation (14 712 kg) of ROPS certification.

Maximum Material Density:

- 2100 kg/m³
- ⊙ 1800 kg/m³
- ⊖ 1500 kg/m³
- 1200 kg/m³
- ◇ 900 kg/m³

Caterpillar recommends using appropriate work tools to maximize the value customers receive from our products. Use of work tools, including buckets, which are outside of Caterpillar's recommendations or specifications for weight, dimensions, flows, pressures, etc. may result in less-than-optimal performance, including but not limited to reductions in production, stability, reliability, and component durability. Improper use of a work tool resulting in sweeping, prying, twisting and/or catching of heavy loads will reduce the life of the boom and stick.

Standard Equipment

Standard equipment may vary. Consult your Cat dealer for details.

CAB

- Pressurized operator station with positive filtration
- ROPS Cab
- Bolt-on FOGS capability
- Laminated glass front window, 70/30 split (tempered glass)
- Mirrors
- Sliding upper door window (left-hand cab door)
- Removable lower windshield with in cab storage bracket
- Windshield washer and radial wipers
- Interior lighting
- Sun Screen
- Coat hook
- Beverage holder
- Literature holder
- Ashtray for cup holder
- 24V Radio mounting
- Glass-breaking safety hammer
- 12V-2×10 amp power supply with two cigar lighter type sockets
- Two stereo speakers
- Storage shelf suitable for lunch or toolbox
- Color LCD display with indicators, filter/fluid change, and working hour information
- Neutral lever (lock out) for all controls
- Seat belt, 51 mm
- Adjustable armrest
- Height adjustable joystick consoles
- Travel control pedals with removable hand levers
- Capability of installing additional pedal

ENGINE

- C3.4B diesel engine
- Meets Stage IIIB emission standards
- 2300 m altitude capability with no derate
- Biodiesel capable
- Two-speed travel
- Side-by-side cooling system
- Fixed fan
- Radial seal air filter
- Standard battery –18° C

HYDRAULIC SYSTEM

- Regeneration circuit for boom and stick
- Automatic swing parking brake
- High-performance hydraulic return filter
- Boom lowering and stick lowering check valves

ELECTRICAL

- Circuit breaker
- Time delay boom and cab lights

LIGHTS

- Working lights, cab mounted
- Halogen boom light (left and right sides)
- Time delay function for boom light and cab light

UNDERCARRIAGE

- Center track guiding guard
- Grease Lubricated Track GLT2
- Towing eye on base frame
- Bottom guards, standard
- Track motor guard

COUNTERWEIGHT

- 2450 kg counterweight

SAFETY AND SECURITY

- Cat one key security system
- Door locks
- Cap locks on fuel and hydraulic tanks
- Signaling/warning horn
- Secondary engine shutoff switch
- Rear window for emergency exit
- Guard rail and handrail
- Mirrors
- Rearview camera

TECHNOLOGY

- Product Link PL522

311F L RR Optional Equipment

Optional Equipment

Optional equipment may vary. Consult your Cat dealer for details.

CAB

- Seat, high-back air suspension with heater
- Seat, high-back mechanical suspension
- Rain protector

ELECTRICAL

- Cold weather battery –25° C
- Jump start receptacle
- Travel alarm
- Electric fuel refueling pump
- Cab light (halogen)

FRONT LINKAGE

- 4.3 m Reach boom (with BLCV/SLCV)
 - 2.8 m HD stick
 - 2.25 m HD stick
- Bucket linkage with lifting eye
- Universal Quick Coupler

HYDRAULIC SYSTEM

- Auxiliary hydraulics
- Boom and stick high-pressure lines
- Boom and stick medium-pressure lines
- Boom and stick Universal Quick Coupler lines
- Universal Quick Coupler circuit
- Cat Bio hydraulic oil

UNDERCARRIAGE

- 500 mm triple grouser shoes
- 500 mm rubber pads triple grouser shoes
- 600 mm triple grouser shoes
- 700 mm triple grouser shoes
- 770 mm triple grouser shoes
- 2500 mm blade with replaceable cutting edge
- 2700 mm blade with replaceable cutting edge
- Heavy duty bottom guard
- Swivel guard

SAFETY AND SECURITY

- FOGS, bolt-on
- Guard, cab front, mesh
- Security system fitted (MSS)

For more complete information on Cat products, dealer services, and industry solutions, visit us on the web at www.cat.com

AEHQ7949
(EU)

© 2017 Caterpillar
All rights reserved

Materials and specifications are subject to change without notice. Featured machines in photos may include additional equipment. See your Cat dealer for available options.

CAT, CATERPILLAR, SAFETY.CAT.COM, their respective logos, "Caterpillar Yellow" and the "Power Edge" trade dress, as well as corporate and product identity used herein, are trademarks of Caterpillar and may not be used without permission.

VisionLink is a trademark of Trimble Navigation Limited, registered in the United States and in other countries.

