

Product datasheet

Overhead sectional door

ASSA ABLOY OH1042FG

ASSA ABLOY

ASSA ABLOY Entrance Systems

The global leader in
door opening solutions



Copyright and Disclaimer Notice

Although the contents of this publication have been compiled with the greatest possible care, ASSA ABLOY Entrance Systems cannot accept liability for any damage that might arise from errors or omissions in this publication. We also reserve the right to make appropriate technical modifications/replacements without prior notice.

No rights can be derived from the contents of this document.

Color guides: Color differences may occur due to different printing and publication methods.

No part of this publication may be copied or published by means of scanning, printing, photocopying, microfilm or any other process whatsoever without prior permission in writing by ASSA ABLOY Entrance Systems.

Copyright © ASSA ABLOY Entrance Systems AB 2006-2017.

All rights reserved.

ASSA ABLOY, Besam, Crawford, Albany and Megadoor as words and logo are trademarks belonging to the ASSA ABLOY Group

Technical facts

Features

Max size: (W x H)*	5500 mm x 4250 mm
Frame thickness:	44 mm
Frame material:	Aluminium tubular frames
Filling:	Windows ≤DLW 3300mm, 1 pane >DLW 3300mm, 2 panes
Colour outside:	Natural aluminium
Colour inside:	Natural aluminium
Track types:	Standard: SL Optional: HL, LL, VL, HHL
Windows:	SH6: 6 mm HG
Electrical operation:	Optional: Automated operation, Access control, Safety functions

Performance

Opening/closing speed:	CDM9: 0,25 m/s CDM9 HD: 0,18 m/s CDM9 2H: opening 0,5 m/s, closing 0,25 m/s
Life time expectations:	Door:50.000 door cycles, Optional 100.00 cycles. Springs:20.000 door cycles
Wind load, EN12424*	Class 3 (≤ 3300 mm DLW)
Thermal transmittance, EN12428	4,8 W/(m ² .K) SH6, Double glass on request (4000 x 4000mm)
Water penetration, EN12425	Class 3 (4000 x 4000 mm)
Air permeability, EN12426	Class 3 (4000 x 4000 mm)

* Higher wind load classification on request

Contents

Copyright and Disclaimer Notice	2
Technical facts	3
Contents	4
1. Description	6
1.1 General	6
1.2 Dimensions	6
1.2.1 Daylight width and daylight height	6
1.2.2 Section sizes	6
1.3 Door leaf	7
1.3.1 Construction	7
1.3.2 Material	7
1.3.3 Vertical cross-section	7
1.3.4 Colors	8
1.3.5 Windows	8
1.3.6 Seals	8
1.3.7 Wind reinforcement truss	9
1.3.8 Handle	9
1.3.9 Lock bolt	9
1.4 Balancing system	10
1.4.1 Safety devices	10
1.5 CEN Performance	11
1.5.1 Lifetime expectation	11
1.5.2 Resistance to windload	11
1.5.3 Resistance to water penetration	11
1.5.4 Air permeability	12
1.5.5 Thermal transmittance	12
1.5.6 Operating forces and safe openings	12
1.6 Track sets	13
1.6.1 General	13
1.6.2 SL - Standard Lift	13
1.6.3 SLL - Standard Low Lift	13
1.6.4 LL - Low Lift	13
1.6.5 HL - High Lift	13
1.6.6 HHL - High lift with spring package at the end of the horizontal track	14
1.6.7 VL - Vertical Lift	14
1.6.8 Special track sets	14
2. Available Options	15
2.1 Fixed sections	15
2.2 Optional colours *	15
3. Specifications	15
3.1 Windows	15
3.1.1 Number of windows	15

4.	Operating system	16
4.1	Types of operation	16
4.1.1	Pull-down rope.....	16
4.1.2	Chain hoist	16
4.1.3	Electrical operation.....	16
4.2	CDM9 Operator - 900 Door control systems	17
4.2.1	CDM9 Operator.....	17
4.3	Selection guidelines for operation type.....	18
4.4	Selection guidelines for door operator	18
4.5	900 Door control systems.....	19
4.5.1	General	19
4.5.2	920 Door control system.....	19
4.5.3	930 Door control system.....	19
4.5.4	950 Door control system.....	19
4.5.5	900 Door control systems - Selection guidelines	19
4.6	900 Door control systems - Selection guidelines for automation	20
4.7	Access and automation.....	21
4.7.1	Basic control functions.....	21
4.7.2	External control functions.....	21
4.7.3	Automatic control functions.....	21
4.7.4	Safety functions.....	22
4.7.5	Additional functions.....	22
5.	Building and space requirements	23
5.1	Building preparations	23
5.1.1	Installation preparations.....	23
5.2	Space requirements	23
5.2.1	Space requirements SL	24
5.2.2	Space requirements HL	25
5.2.3	Space requirements HHL.....	26
5.2.4	Space requirements LL	27
5.2.5	Space requirements VL.....	28
6.	Service	29
	Index	30

1. Description

1.1 General

The ASSA ABLOY OH1042FG Overhead sectional door is one of the most stable overhead doors on the market.

It is an overhead sectional door, suitable for all types of buildings, with regard to both function and appearance. High flexibility makes it possible to install this door in almost every type of building.

The door slides up under the roof when opened, allowing free space around the door opening and leaving the door opening completely free.

The door is made of aluminium tubular profiles, filled with windows. The high light admission makes this door the ideal choice for working environments that require maximum lighting.

The ASSA ABLOY OH1042FG Overhead sectional door has been designed to meet all operational and safety requirements in the European Directives and the standards issued by the European Standardization Committee, CEN.

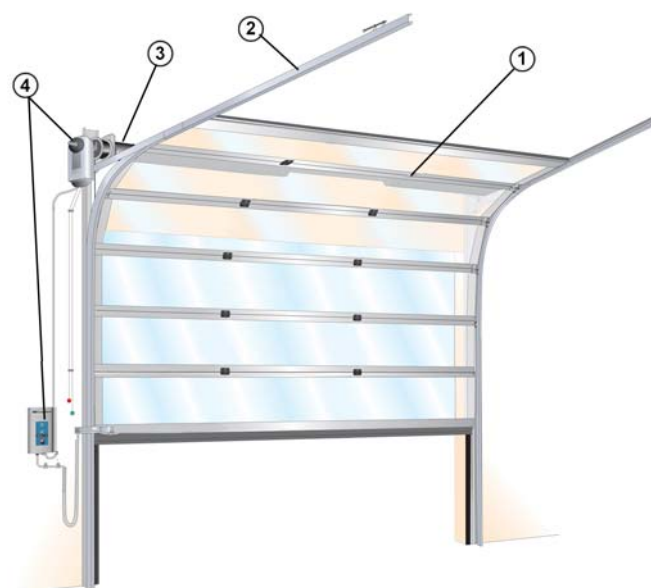

The door has 4 primary parts:

- 1) Door leaf
- 2) Track set
- 3) Balancing system
- 4) Operating system

1.2 Dimensions

1.2.1 Daylight width and daylight height

The ASSA ABLOY OH1042FG Overhead sectional door is delivered in the following size range:

	Daylight width	Daylight height
Min.:	2050 mm	1979 mm
Max.:	5500 mm	4250 mm

1.2.2 Section sizes

Section height:	400 - 600 mm*
Thickness:	44 mm

*The door leaf height is equally divided over the sections (standard).

Number of sections

DLH Frame bottom section	Number of sections
0000 - 1979	3
1980 - 2579	4
2580 - 3179	5
3180 - 3779	6
3780 - 4250	7

1.3 Door leaf

1.3.1 Construction

The ASSA ABLOY OH1042FG Overhead sectional door leaf has horizontal sections, connected together with hinges. The outer hinges of each section have rollers that run in the tracks.

The horizontal sections are aluminium tubular frames with full windows.



1.3.2 Material

The sections are made of tubular aluminium frames, equipped with windows.

The bottom section is a frame construction with windows, but can, if required, be delivered as an insulated panel.

1.3.3 Vertical cross-section

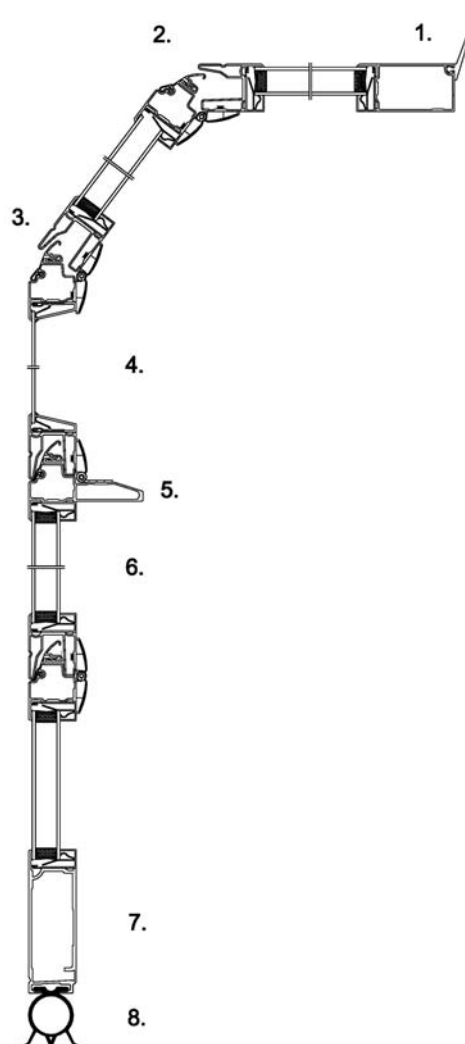

- 1) Top seal
- 2) Integrated finger pinch protection
- 3) Sealing in section joint
- 4) Single hardened 6 mm glass (standard)
- 5) Panel truss - wind reinforcement (if necessary)
- 6) Double glass, 27mm (on request)
- 7) Frame bottom section
- 8) Bottom seal

1.3.4 Colors

The ASSA ABLOY OH1042FG Overhead sectional door is available in any color on request. As standard, the frames are delivered in natural anodized aluminium.

1.3.4.1 Standard colours

Frames

- The frames are delivered as a standard in natural aluminium.

1.3.5 Windows

The frame construction allows full windows in all sections. The light opening is equal for all window types and depends on the dimensions of the door leaf.

1.3.5.1 SA/SH

SH6: Single hardened glass 6 mm



Double hardened glass on request

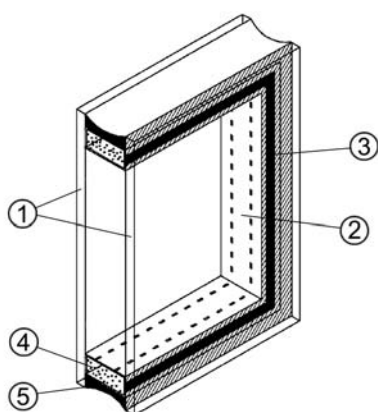

- 1) Double hardened glass
- 2) Aluminium distance frame
- 3) Butyl sealing
- 4) Absorbing siccative
- 5) Silicone sealing

1.3.6 Seals

The door is equipped with well designed seals on all sides that gives the door its excellent sealing abilities.

1.3.6.1 Top seal

The top seal is installed on the top panel to seal the gap between the panel and the wall. The EPDM rubber top seal ensures an optimal insulation and tightness.



1.3.6.2 Side seal

Installed on the track set to close the gap between the tracks and the door leaf. The double lip side seal design with insulation chambers ensures an optimal insulation and sealing.



1.3.6.3 Bottom seal

Installed on the bottom edge of the bottom panel, to act as a barrier as well as a shock absorber. The flexible EPDM rubber material and the O-shape provides continuous pressure on the floor, ensuring maximum sealing. The bottom seal is mounted in an ABS adapter for optimal insulation and reduced risk of condensation.



1.3.9 Lock bolt

A standard ASSA ABLOY OH1042FG Overhead sectional door is equipped with a Lock bolt. The Lock bolt locks the door from the inside, without the use of a key.



1.3.7 Wind reinforcement truss

Wider door panels and panels with windows are reinforced with metal profiles that act as trusses. These trusses reduce bending of the panel caused by wind loads or when the door leaf is in the horizontal position and is bending under its own weight. The wind reinforcement truss is integrated in the aluminium profiles.

1.3.8 Handle

For manual operation, every ASSA ABLOY OH1042FG Overhead sectional door is provided with a solid, easy to grip handle.



1.4 Balancing system

The balancing system balances the door by applying a force nearly equal to the weight of the door leaf. This allows the door leaf to be moved up and down manually, and to stay open in any position.

The system is installed on the top or the end of the track set and works as follows: Two torsion springs are installed on a shaft above the door opening. This shaft has a cable drum on each end from which door cables run to the bottom corners of the door leaf. Turning the shaft moves the door up or down.

1.4.1 Safety devices

The balancing system supports heavy forces. In case of a spring or cable break, its counterforce is lost. The door is therefore equipped with two safety devices that can block downward door movement:

- Spring Break Device (standard)
- Cable Break Device (optional)

1.4.1.1 Spring break device (SBD)

The Spring Break Device (SBD) is delivered with all ASSA ABLOY OH1042FG Overhead sectional doors.

In the event of a spring break, the sudden drop force activates the Spring Break Device (SBD). The shaft will be locked in less than 300mm of door movement.

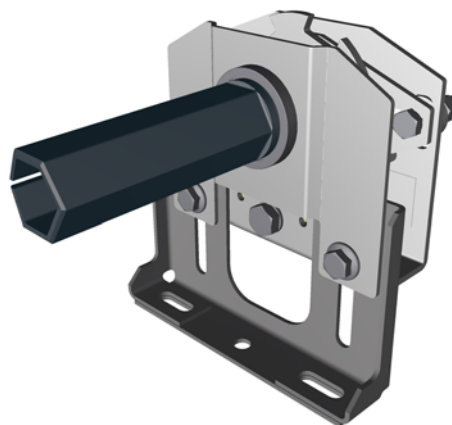

1.4.1.2 Cable break device (CBD)

The Cable Break Device (CBD) is an optional safety device. In the event of a cable failure the door leaf will be blocked in less than 300mm to avoid damage.



1.5 CEN Performance

1.5.1 Lifetime expectation

- 50.000 door cycles or 10 years (in a normal industrial environment) 100.000 door cycles optional
- Springs: 20.000 door cycles

1.5.2 Resistance to windload

EN12424

Test result	Class 3 (\leq DLW 3300mm)
	Class 2 ($>$ DLW 3300mm)

Class	Pressure Pa (N/m ²)	Specification
0	-	No performance determined
1	300	
2	450	
3	700	
4	1000	
5	$>$ 1000	Exceptional : Agreement between manufacturer and supplier

Door size 4000 x 3450 mm

1.5.3 Resistance to water penetration

EN12425

Test result	Class 3 (no passdoor)
-------------	-----------------------

Class	Pressure Pa (N/m ²)	Specification
0	-	No performance determined
1	30	Waterspray for 15 minutes
2	50	Waterspray for 20 minutes
3	$>$ 50	Exceptional : Agreement between manufacturer and supplier

1.5.4 Air permeability

EN12426	Without passdoor
Test result	Class 3

Class	Air permeability dp at a pressure of 50 Pa (m³/m²/h)
0	-
1	24
2	12
3	6
4	3
5	1,5
6	Exceptional : Agreement between manufacturer and supplier

1.5.5 Thermal transmittance

EN12428	Single glass	Double glass
Thermal transmittance	4,8*	On request

Door size 4000 x 4000 mm

1.5.6 Operating forces and safe openings

EN12453 & EN12604	Crushing force N	Crushing force N	Crushing force N
Opening gap mm	200 mm from lateral border right from outside	In the middle of the door opening	200 mm from lateral border left from outside
50 mm	passed	passed	passed
300 mm	passed	passed	passed

The crushing force is the force needed for the safety edge to be activated. The maximum force allowed, according to EN12453 safety in use of power operated doors is 400 N within a maximum period of time of 0.75s. With standard light curtain there is no crushing force.

1.6 Track sets

1.6.1 General

The track set supports the door leaf on its rollers and guides it upwards. The selection of the appropriate track set is based on various factors:

- Available head room
- Door height
- Type of vehicles
- Presence of roof obstructions, pipes and overhead crane beams.

The track sets below cover most applications. Other applications are available on request.

1.6.2 SL - Standard Lift

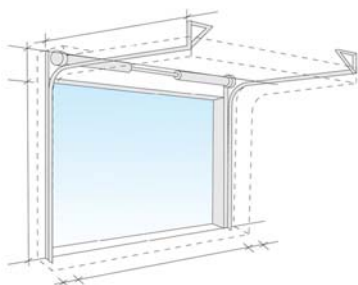

- Building type: Most standard industrial buildings.
- Benefits: Optimal design for common buildings.

The Standard Lift track set, with the spring package just above the door, is the most common solution

1.6.3 SLL - Standard Low Lift

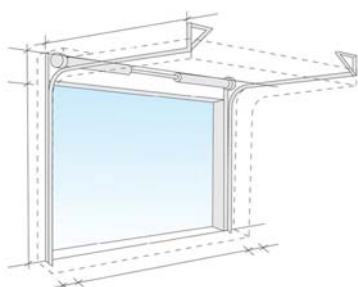

- Building type: Low ceilings.
- Benefits: Achieve more daylight height with a limited head room.

The Standard Lift Low track set is a variant of the Low Lift where the spring package is installed just above the door.

1.6.4 LL - Low Lift

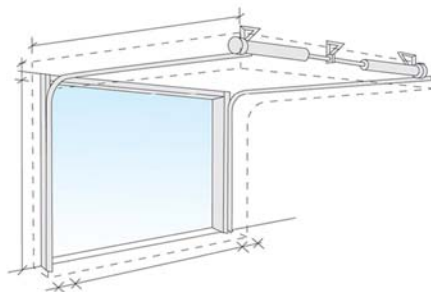

- Building type: Low ceilings.
- Benefits: Achieve maximum daylight height with minimum head room.

Same as standard lift, but with the spring package at the end of the horizontal tracks.

1.6.5 HL - High Lift

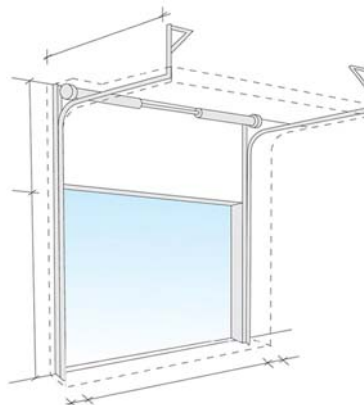

- Building type: High ceilings. On the High Lift track set the spring package is placed high above the door.
- Benefits: This track type allows high vehicles to cross along the door opening without obstructions of the horizontal tracks.

This track type is used when the space above the door is considerable, and is needed for work and traffic, e.g.: high vehicles.

1.6.6 HHL - High lift with spring package at the end of the horizontal track

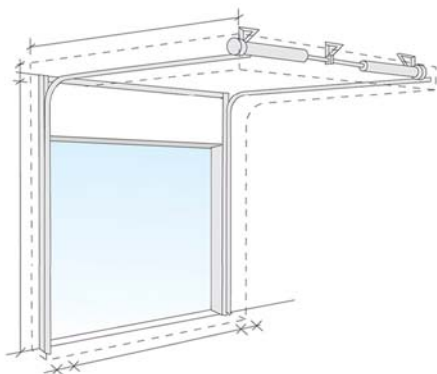

- Building type: High ceilings. Used when space between ceiling and lower edge of horizontal track is limited.
- Benefits: Achieve maximum highlift with minimum head room.

High lift hardware with the spring package placed in the end of the horizontal track.

1.6.7 VL - Vertical Lift

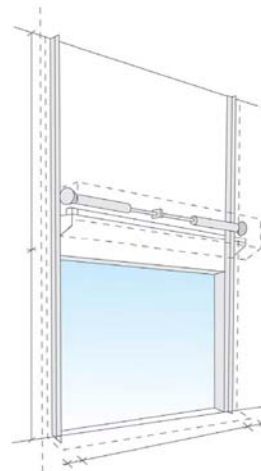

- Building type: Very high ceiling and high working space requirements.
- Benefits: Allows high vehicles to cross along the door opening without any obstructions.

If the space between the daylight height and the roof is sufficient, with this track type, the door can be opened vertically.

1.6.8 Special track sets

The ASSA ABLOY OH1042FG Overhead sectional door track set can be custom designed to make the door fit in places that seem quite impossible. Our door technicians can solve installation problems where the door must share space with ventilation systems, crane beams, etc. For example:

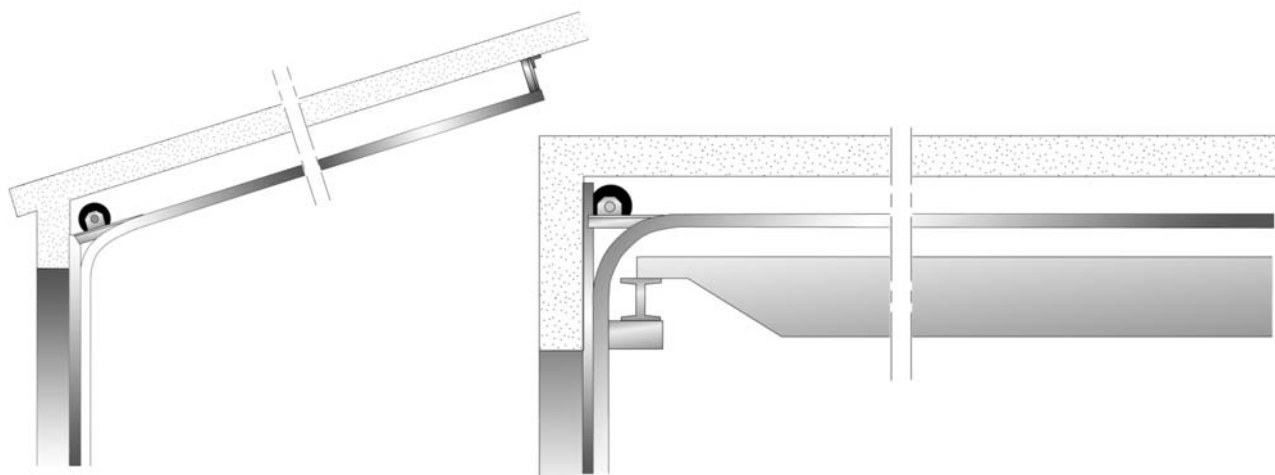

2. Available Options

2.1 Fixed sections

Fixed sections can advantageously fill space around new doors that are smaller than the wall opening. Fixed sections are available in top and side sections. Fixed sections are supplied in the same color and construction as the door leaf.

A fixed section can be provided with a passdoor for two reasons: Safety and energy cost reduction.

- Safety: Putting a separate passdoor in a fixed section next to the industrial door separates pedestrian and vehicle traffic.
- Energy cost reduction: The opening space for frequent pedestrian traffic is minimized.

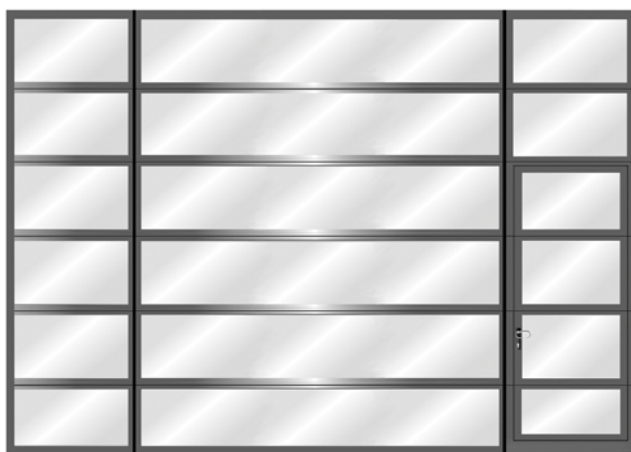

2.2 Optional colours *

Frames

- Factory painting, all RAL colours

3. Specifications

3.1 Windows

3.1.1 Number of windows

For windows the daylight width is divided into a fixed grid. The number of windows depends on the daylight width of the door.

Daylight width	No. of windows
2050 - 3300 mm	1
3301 - 5500 mm	2

4. Operating system

4.1 Types of operation

The ASSA ABLOY OH1042FG Overhead sectional door can be opened and closed manually. They are also prepared for electrical operation. Electrically operated doors can be controlled by hand or be fully automatic. Traffic frequency, climate requirements and the weight of the door play a key role in choosing the optimal control system.

4.1.1 Pull-down rope

The ASSA ABLOY OH1042FG Overhead sectional door can be operated manually with a pull-down rope. The pull-down rope is directly connected to the door leaf.

4.1.2 Chain hoist

For heavier doors, a chain hoist allows easier door operation. There are three types of chain hoist:

D-hoist:



- D-hoist: Non-geared chain transmission directly connected to the shaft. Recommended for doors up to 250 kg (For hexagonal shaft only).

T-hoist:

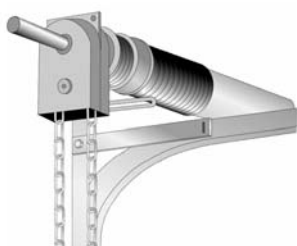

- T-hoist: Geared (ratio 1:4) chain transmission directly connected to the shaft. Recommended for doors up to 250 kg (For all shaft types).

U-hoist:



- U-hoist: Geared (ratio 1:3) indirect chain transmission. Recommended for doors of 250 kg and above (For all shaft types).

4.1.3 Electrical operation

The ASSA ABLOY OH1042FG Overhead sectional door can be supplied or upgraded with an electrical operating system. Electrical operation gives access to the full program of Access and Automation functions, that can fulfill many operational needs, related to traffic type and frequency, door weight and temperature control.



4.2 CDM9 Operator - 900 Door control systems

The CDM9 operator is a combination of the CDM9 operator and a 900-series Door control system. The regular CDM9 model is available for doors up to 400 kg. The CDM9 HD model is available for doors up to 800 kg. The double speed CDM9 2H model is available for doors up to 250 kg.

4.2.1 CDM9 Operator

One main part of the system is the operator: an electric motor which drives the balancing shaft with the cable drums and torsion springs. It can be retrofitted to an already installed door. The CDM9 operator is mounted directly on the balancing shaft and does not require any special wall reinforcement. The CDM9 can also be equipped with an integrated geared (ratio 1:3,5) chain hoist.

Key features:

- Smooth and silent
- Soft start and stop
- Fits all track types and shafts
- Life time: 84.000 - 300.000 door cycles (depending on weight and temp.) e.g.:
 - temp. 0 °C - +40 °C/weight 250 kg = 300.000 cycles
 - temp. -20 °C - +60 °C/weight 400 kg = 84.000 cycles



	CDM9	CDM9 HD	CDM9 2H
Voltage supply: +/- 10%	230V AC 1-phase 50/60Hz	230V AC 1-phase 50/60Hz	230V AC 1-phase 50/60Hz
Power:	0,37 kW	0,6 kW	0,37 kW
Degree of protection:	IP55, excl. connector IP 44	IP55, excl. connector IP 44	IP55, excl. connector IP 44
Allowed door weight, max.:	400 kg	800 kg	250 kg
Temperature working range:	-20 °C to +55 °C*	-20 °C to +55 °C*	-20 °C to +55 °C*
Operating factor:	ED = 30% S3 10 min. intermittent	ED = 30% S3 10 min. intermittent	ED = 30% S3 10 min. intermittent
Mounting preparations:	-	When installing on the wall, an extra attachment angle is required	-

*) Normal opening speed in a temperature down to -8°C. In the temperature range -8 °C to -20 °C the opening speed is reduced during the first cycle to prolong the operator's lifetime. An optional heating element is available for a working range down to -30 °C

4.3 Selection guidelines for operation type

Door size m ²	Openings / day			
	1-5 day	5-10 day	10-15 day	>25 day
0 – 10	□ / ■	□ / ■	■ / ■	■ / ■
10 – 20	□ / ■	■	■ / ■	■ / ■
> 20 - 42	■	■	■ / ■	■ / ■
> 42*	■	■	■ / ■	■ / ■

- Manual operation
- Electrical operation
- Automated operation

4.4 Selection guidelines for door operator

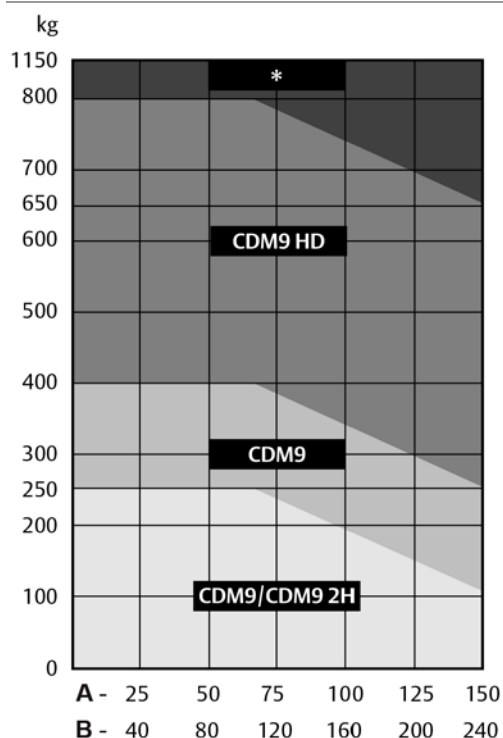

Door openings/day

1. Over 300 days/year
2. Over 220 days/year

Average door weight

- Steel door : 13 kg/m²
- Alu door : 10 kg/m²

4.5 900 Door control systems

4.5.1 General

The 900 Door control system series provides a range of control units, from basic up, stop and down buttons to advanced automated control. The 900 series door control units have a IP 55 classification.

The design of all control units is based on modules, and it is possible to upgrade or downgrade safety or automation functions. Additional kits such as magnetic loop, photocells, radar, radio and reduced door opening are available.

4.5.2 920 Door control system

The 920 Door control system is the basic control unit that has the necessary hold-to-run or impulse open, hold-to-run close and stop functions and a slot for an external control box.

This control unit is the economical solution for working environments where the door opening frequency is low.



4.5.3 930 Door control system

The 930 Door control system is a basic control unit that has impulse up and down functions with supervised safety edge. An extra set of upgrade features, such as external control, that can be installed during or after installation, is available. This control unit is the more advanced solution for door openings that are frequently used by pedestrians and forklift trucks, because of its automated opening and closing function.



4.5.4 950 Door control system

The 950 Door control system is the most advanced control unit that is prepared for one or more physical upgrades from the entire range of automation systems. An automation system allows door operation by sensors or remote control. This control unit contains a 3-digit diagnostics display that allows efficient troubleshooting and displays the number of door cycles. Together with the service indicator, this extra feature allows advanced maintenance planning to users where the door is an essential element of internal logistics.



4.5.5 900 Door control systems - Selection guidelines

Functions included	920	930	950
Open (by impulse)	■	■	■
Open (hold to run)			
Stop	■	■	■
Close (by impulse)		■	■
Close (hold to run)	■		
Safety edge		■	■
Open function		■	■
One button function			■
Display (diagnostics)			■
Service indicator			■

■ Standard

□ Option / Available

4.6 900 Door control systems - Selection guidelines for automation

The “Automation D-kits” are packages of common combinations. These kits can also be supplemented by “additions to D-kits”.

Automation D-kits	D1	D2	D3	D4	D5	D6	D7
Interlocking	■	■	■	■	■	■	■
Magnetic loop		■		■		■	
Traffic lights - Green + Red					■	■	
Warning lights - Red	■			■			
Additions to D-kits							
Warning lights - Green			□				
Relay box	□	□	□	□	□	□	□
Radar	□	□	□	□	□	□	□

■ Standard

□ Option / Available

The following options can be individually selected to add functionality to the control unit.

Functions optional	920	930	950
			

Complete kits

Automation D-kits □

Basic control functions

Interlocking □

Reduced opening □

External control functions

External pushb. box □

Pull-rope switch □

Remote control open/stop/close □

Remote control 1-button function □

Automatic control functions

Automatic closing □

Photocell open door □

Safety functions

Safety photocell (1 or 2) □

French safety logic □

Additional functions

UPS Battery backup □

Relay box □

■ Standard

□ Option / Available

4.7 Access and automation

ASSA ABLOY offers a wide range of functions that allows advanced opening and safety control. Please refer to the specification sheet of the control units to see which functions apply to which models.

4.7.1 Basic control functions

4.7.1.1 Interlocking



Developed for climate control or safety; If door A is open, door B cannot be opened. If door B is open, door A cannot be opened. An interlocked door can remember an up-command, if selected via a micro switch.

4.7.1.2 Reduced opening

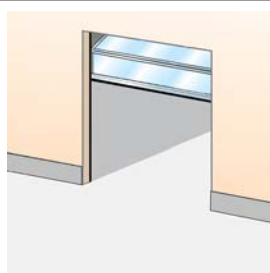

When it is unnecessary or undesirable to fully open a door, an additional switch can be used to open the door to a pre-programmed reduced opening position.

4.7.2 External control functions

4.7.2.1 External push button box

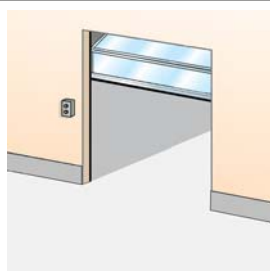

An extra control box is installed outside the building or inside close to the door if the main control unit needs to be installed away from the door opening. Installed on the inside or outside wall beside the door.

4.7.2.2 Pull-rope switch

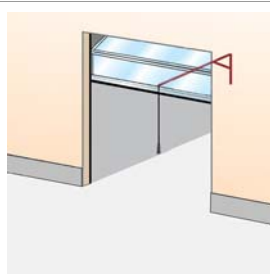

A pull-rope switch above the door opening can be operated from e.g. a forklift truck. Pulling the rope opens a closed door or closes an opened door. Installed on the inside construction above the door.

4.7.2.3 Remote control

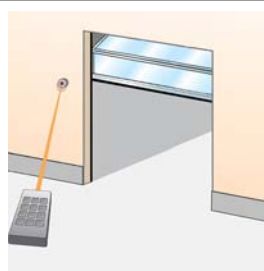

A hand-held radio transmitter allows door operation from a vehicle or any position within 50-100 meters from the receiver and aerial at the door. For closing, the door can be provided with a photocell beam. Receiver installed in control unit, antenna installed on the wall beside the door.

4.7.3 Automatic control functions

4.7.3.1 Magnetic loop

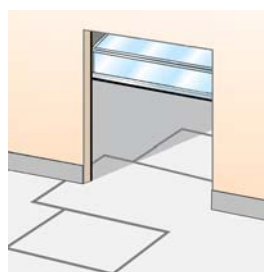

A sensor in the floor detects a metal object (usually forklift trucks, pallet trucks) and opens the door automatically. This is an ideal solution for frequent vehicle traffic. Installed on the outside, inside or both sides of the door in the floor.

4.7.3.2 Radar

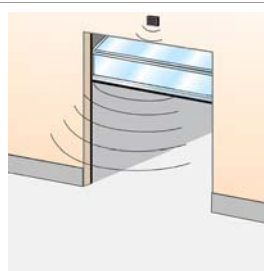

An infrared sensor above the door detects an object (person, vehicle) within a specified distance from the door and opens the door automatically. This is an ideal solution for frequent vehicle or personal traffic. Often combined with automatic closing. Installed on the inside or outside wall above the door.

4.7.3.3 Photocell open door

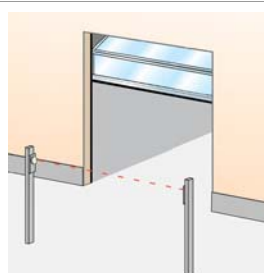

A set of photocells on pillars, on each side of the door. When a person or vehicle passes between the photocells, the beam is interrupted and the door opens. Photocells installed on pillars, away from the door.

4.7.3.4 Automatic closing

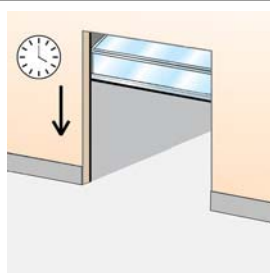

A programmable timer that closes the door after a specified time, counted from either the fully open position and/or from passing through the photocell beam. Adjustable micro switches in control unit.

4.7.4.5 Warning lights - Green

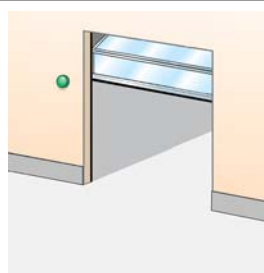

One or two green warning lights indicating the open position of the door by continuous light signal. Installed on the inside and/or outside wall beside the door.

4.7.4 Safety functions

4.7.4.1 Safety edge

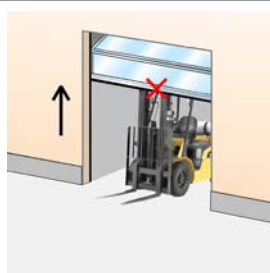

As a standard, all doors that have the impulse-close function or any form of automated closing, are equipped with a safety edge. The pneumatic sensor in the bottom seal detects any obstruction under a closing door and reverses the door. Installed in the bottom seal.

4.7.4.6 Traffic lights - Red & Green

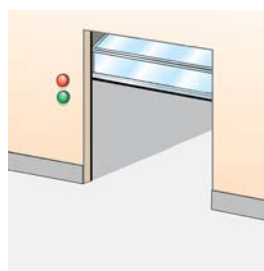

If traffic through a door needs to be directed; two red and two green traffic lights can be installed to indicate traffic direction. From the side where a vehicle is first detected to approach the door, the green traffic light comes on. The opposing side shows a red traffic light. Traffic from this direction must give way to the other. Usually installed in e.g. parking garages. Installed on the inside and outside wall beside the door.

4.7.4.2 Safety photocells 1-channel

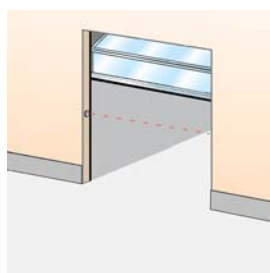

A set of a photocell transmitter and receiver is installed in the door opening. If the photocell beam is interrupted during closing, the door will stop in less than 30mm and reverse to the fully open position. Installed in the door opening.

4.7.5 Additional functions

4.7.5.1 UPS battery backup



When mains failure cannot be permitted or an increased risk of mains failure is predicted, the UPS battery backup system can be installed to store enough energy for 5 door cycles. Installed on the inside wall beside the door.

4.7.4.3 Safety photocells 2-channel

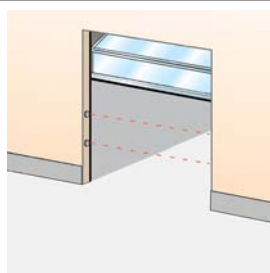

Two sets of photocell transmitter and receiver are installed in the door opening. If one or both photocell beams are interrupted during closing, the door will stop in less than 30mm and reverse to the fully open position. Installed in the door opening.

4.7.5.2 Relay box



A sealed connection box makes it possible to safely connect external high-voltage equipment.

4.7.4.4 Warning lights - Red

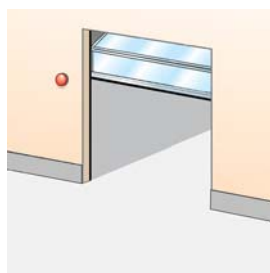

Two red warning lights giving information on the current door behaviour. Flashing light before or during door movement. Optional: Continuous light before and during door movement. Installed on the inside and outside wall beside the door.

5. Building and space requirements

5.1 Building preparations

5.1.1 Installation preparations

The ASSA ABLOY OH1042FG Overhead sectional door is shipped in parts and installed on-site. All necessary installation material is included. For every track type ASSA ABLOY offers specific installation kits to position the door in the building facade.

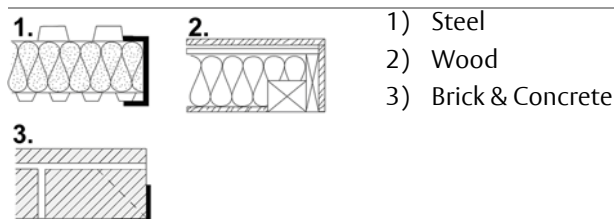

5.2 Space requirements

DLH	= Daylight Height	The height of the clear opening
DLW	= Daylight Width	The width of the clear opening
D	= Depth	The space between the inner side of the wall and the end of the horizontal track construction
h	= Excess height	The extra space required above the daylight height.
SL	= Side space Left	The space required for tracks beside the daylight width.
SR	= Side space Right	The space required for tracks beside the daylight width.

The grey marked area in the illustrations shows the free space required by door movement. Extra space requirements for electrically operated doors are stated in the operator specifications. Extra space requirements for passdoors are stated in the passdoor specifications.

5.2.1 Space requirements SL

h	485 mm (DLH ≤ 4500 mm) 510 mm (DLH > 4500 mm) 575 mm (with center operator)
SL/SR	132 mm Manual, 212 mm Hoist-D/T, 278 mm Hoist-U, 270 mm Operator, 310 mm Operator+Hoist (with outer support bearing + 45 mm)
D	DLH + 600 mm
For details see the specific building preparation drawings	

Side and top view

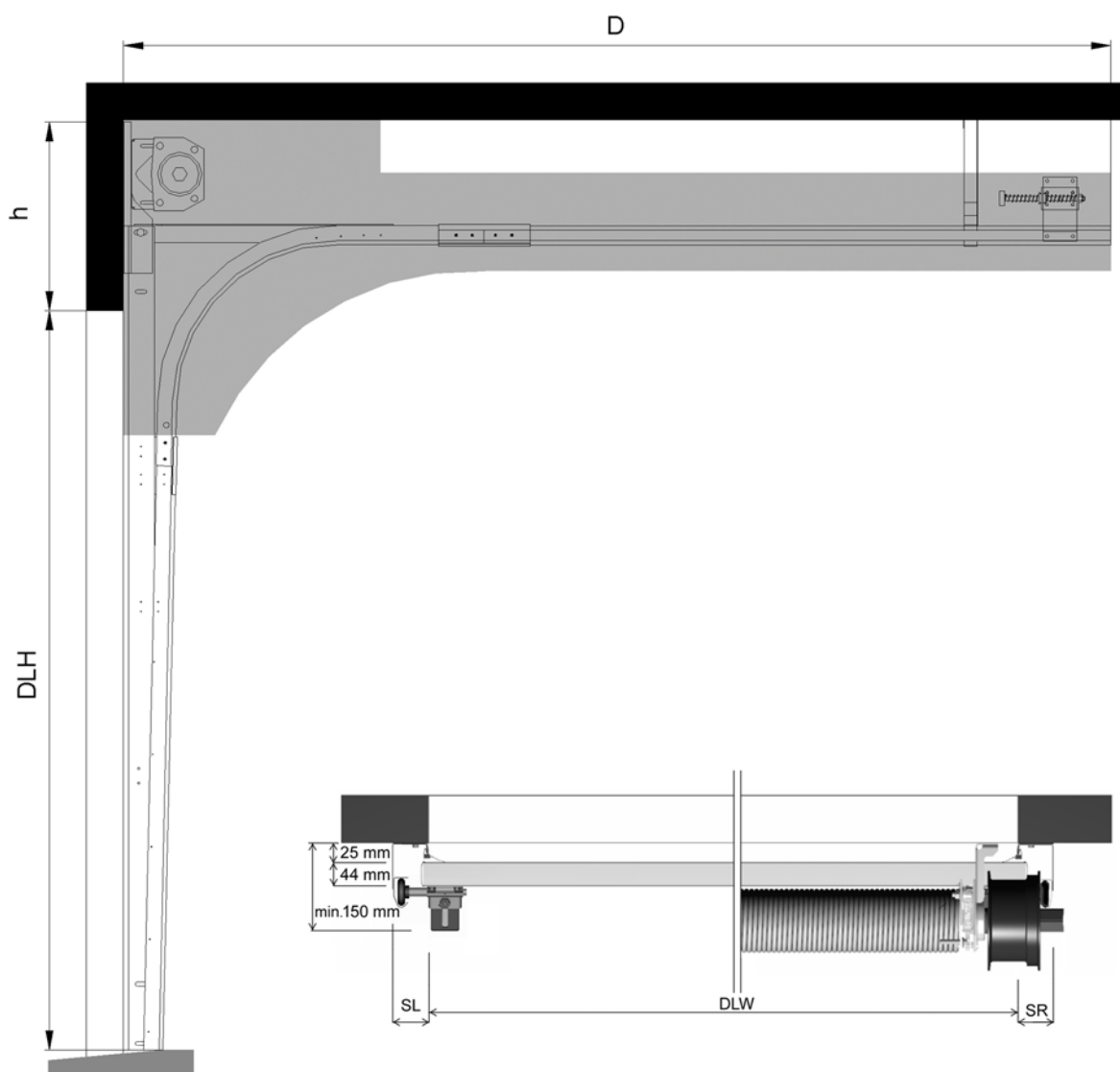

5.2.2 Space requirements HL

	HL	HL with Beam
h	HL+320 mm (HL ≤ 3400 mm) HL+370 mm (HL > 3400 mm) HL +400 mm (with center operator)	HL+220 mm
SL/SR	132 mm Manual, 212 mm Hoist-D/T, 278 mm Hoist-U, 270 mm Operator, 310 mm Operator+Hoist (with outer support bearing + 45 mm)	106 mm Manual, 212 mm Hoist-D/T, 278 mm Hoist-U, 312 mm Operator, 352 mm Operator+Hoist (with outer support bearing + 64 mm)
D	DLH - HL + 800 mm	DLH - HL + 800 mm

For details see the specific building preparation drawings
*We would advise the following doors to be installed on a frame, equipped with an A-65 top seal.
Doors DLW > 6000 mm
Doors DLW ≥ 4000 mm with a dark outside colour, frequently exposed to solar heat.

Side and top view

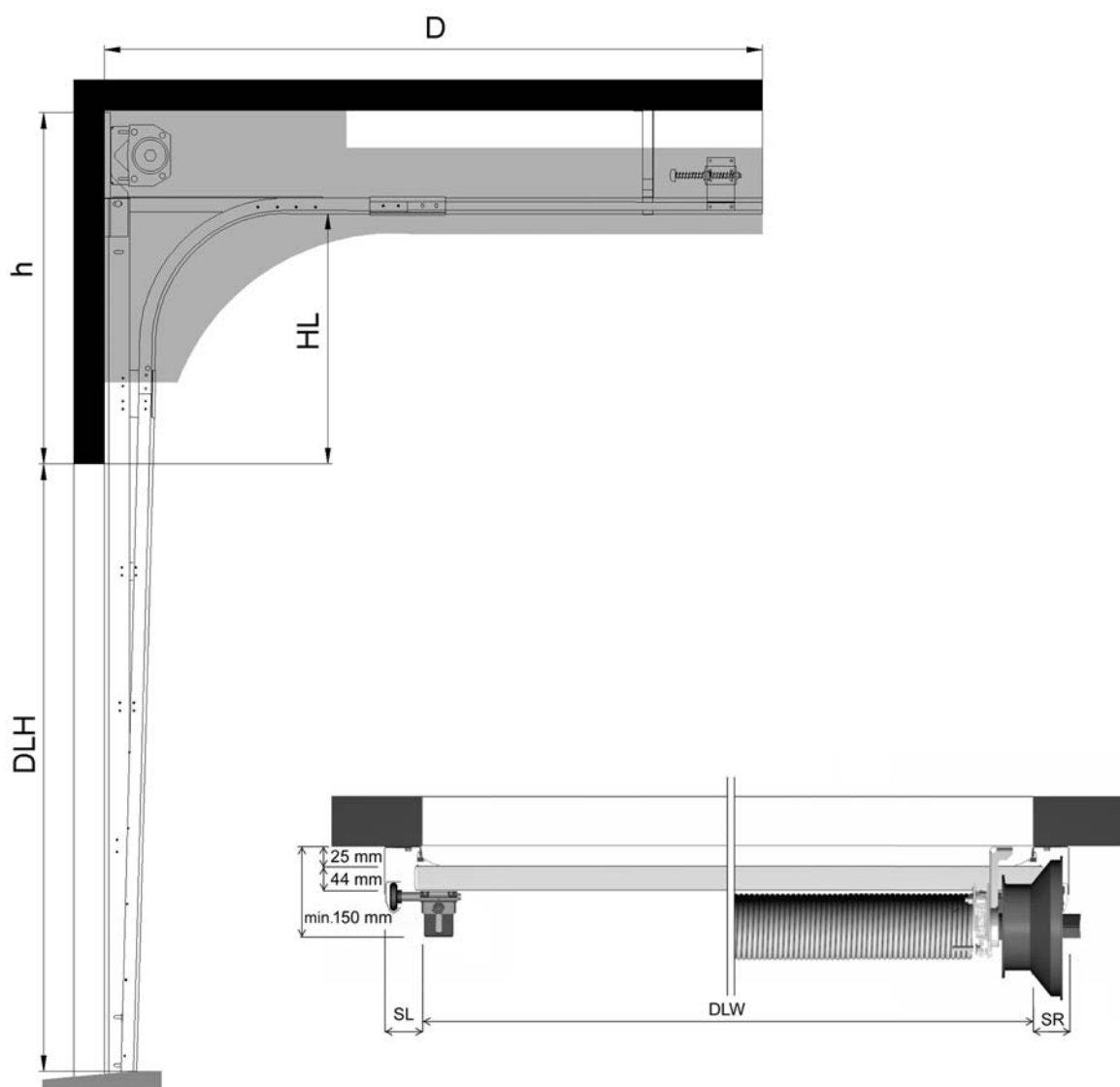

5.2.3 Space requirements HHL

h	HL+350 mm
SL/SR	132 mm Manual, 228 mm Hoist-D/T, 278 mm Hoist-U, 304 mm Operator, 344 mm Operator+Hoist (with outer support bearing + 45 mm)
D	DLH - HL + 1100 mm
<p>For details see the specific building preparation drawings * We would advise the following doors to be installed on a frame, equipped with an A-65 top seal. Doors DLW > 6000 mm Doors DLW ≥ 4000 mm with a dark outside colour, frequently exposed to solar heat.</p>	

Side view

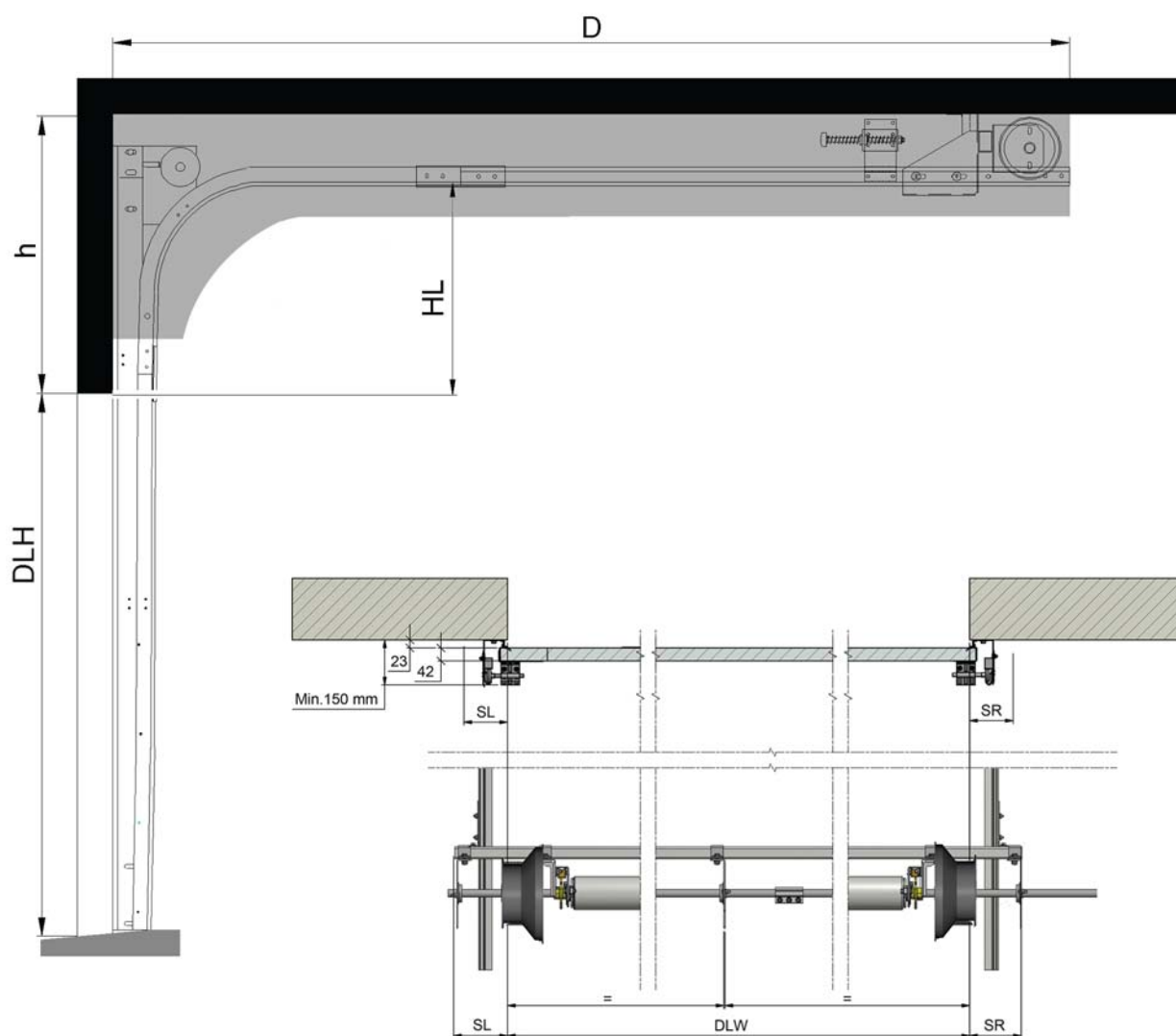

Top view

5.2.4 Space requirements LL

h	265 mm (≤ 250 kg without passdoor) 300 mm (> 250 kg or passdoor)
SL/SR	132 mm Manual, 228 mm Hoist-D/T, 278 mm Hoist-U, 304 mm Operator, 344 mm Operator+Hoist (with outer support bearing + 45 mm)
D	DLH + 1100 mm
	For details see the specific building preparation drawings *** With low threshold passdoor only

Side and top view

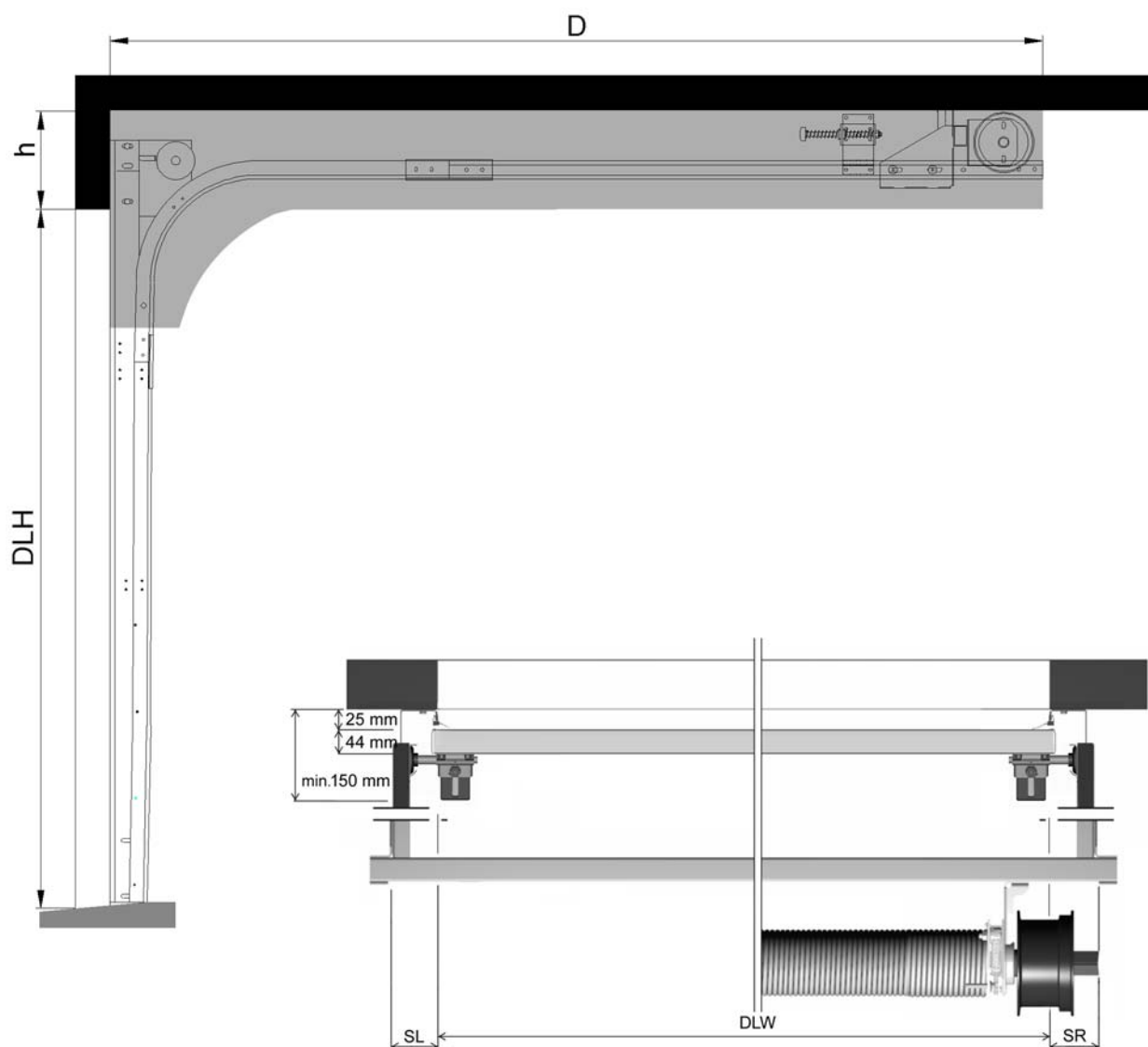

5.2.5 Space requirements VL

h	DLH + 365 mm
SL/SR	110 mm Manual, 216 mm Hoist-D/T, 278 mm Hoist-U, 312 mm Operator, 352 mm Operator+Hoist (with outer support bearing + 64 mm)
D	VLA = 450 mm VLT = 525 mm (manual) VLT = 610 mm (operator)

For details see the specific building preparation drawings

- VL doors: DLW ≤ 3000 mm and DLH ≤ 3350 = VLA = no beam installed
- VL doors: DLW > 3000 mm or DLH > 3350 = VLT = installed with beam to support the balancing system

We would advise the following doors to be installed on a frame, equipped with an A-65 top seal.

- Doors DLW > 6000 mm
- Doors DLW ≥ 4000 mm with a dark outside colour, frequently exposed to solar heat.

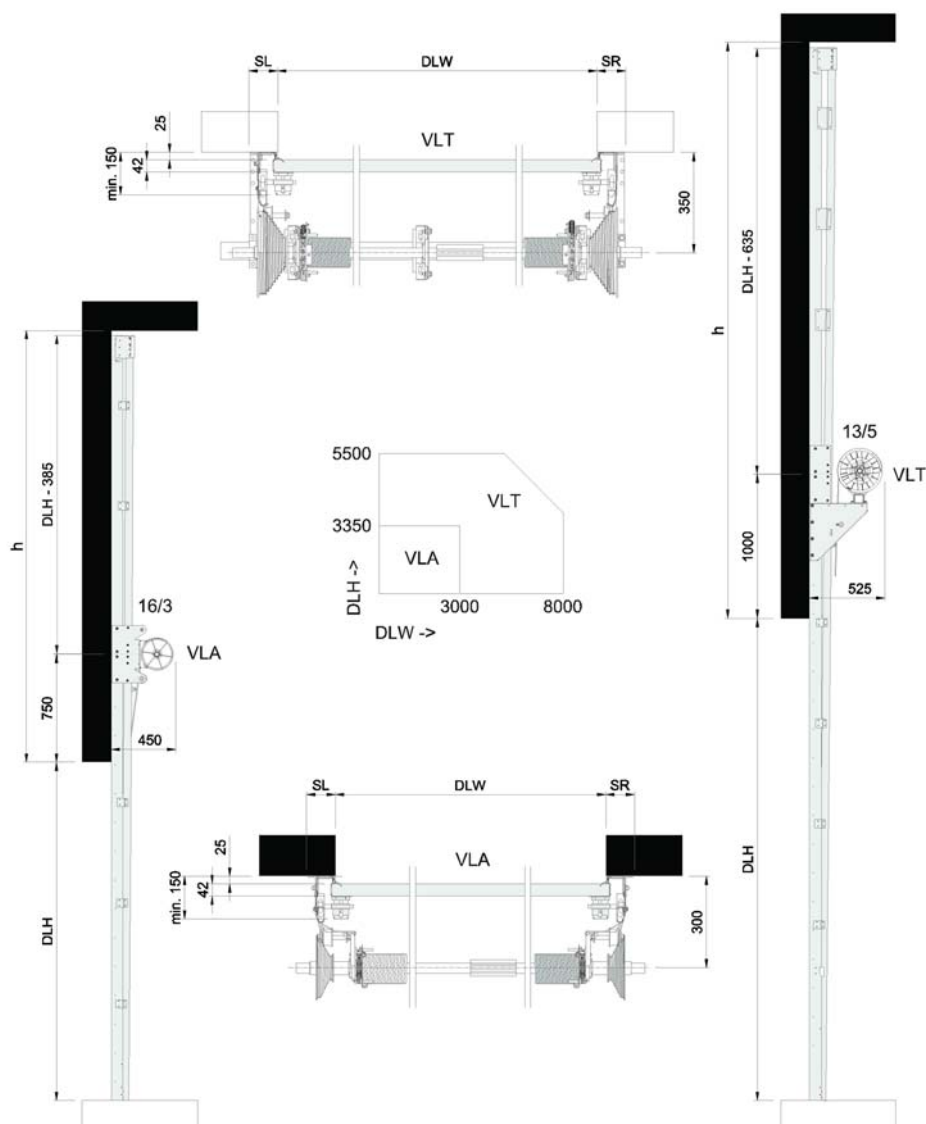

6. Service

Preventive Maintenance Program and Modernization Services

As your entrances are part of your business flow, there's every reason to keep them working well. ASSA ABLOY Entrance Systems offers you a maintenance and modernization expertise to rely on. Our Maintenance Programs and Modernization Services are backed by a extensive expertise for all types of industrial door and docking systems, independent of brand. At your disposal is a team of dedicated expert technicians, proven through decades of maintenance, service and satisfied customers.

Preventive Maintenance Programs

Minimizing lost time, lost energy and unexpected hassle is our team's constant objective. Our service organization can support you 24/7 in maintaining all industrial door and docking systems, independent of brand. If you want to be one step ahead of break-downs, explore our portfolio of Pro-Active Care plans. Naturally, we also offer entrance upgrades to suit your specific wishes and business needs.

Pro-Active Care - Maintenance plans to fit your business

Regular maintenance can extend the lifetime of your equipment and help prevent unexpected problems. Our technician arrives on-site equipped with the knowledge and tools to service all automatic entrances, independent of brand.

- **Pro-Active Bronze**

The base on which all Pro-Active Plans are built provides the security of knowing that your equipment is regularly inspected and certified for safety, as well as performing optimally. It includes a number of planned on-site visits depending on your needs. Any unplanned service calls required during the term of the contract (including labor, travel and parts) are billed at special Pro-Active Care prices.

- **Pro-Active Silver**

This plan provides all the benefits of Pro-Active Bronze with the added advantage of labor and travel being included for service calls during regular business hours. The only additional charge would be for any parts that may be needed throughout the term of the contract.

- **Pro-Active Gold**

This plan provides the ultimate protection for your automatic entrance investment. It includes all the benefits of Pro-Active Silver, plus replacement of any parts required during an unplanned repair or planned maintenance visit. Pro-Active Gold is an excellent way to budget your automatic door expenses annually.

- **Pro-Active Tailor-Flex**

Our most flexible maintenance and service offering. The Pro-Active Care plan is designed by you, our customer. The plan allows you to balance your maintenance expenses against your real-world budget and presents the option to add or delete a number of maintenance elements to suit your budget goals, while meeting your overall performance and safety needs.

Modernization

Your entrances are a long-term investment, from which you always want the best. Products develop over time, so do regulations and your business. Let us help you increase energy savings and meet today's standards. We provide advice and modernization kits for outdated installations, ensuring your investment meet requirements and performs optimally for many more years to come.

Re-Active Service		Pro-Active Care				
Corrective	SafetyCheck	Pro-Active Bronze	Pro-Active Silver	Pro-Active Gold	Pro-Active Tailor Flex	
		○	○	○	●	Other customized requests such as Response Time, Performance InfoPack and Advanced User Training
		○	○	●	○	Replacement of worn parts according to preventive Consumable Exchange Program
		○	○	●	○	Replacement of spare parts on breakdowns
		○	●	●	○	Travel and labor for additional call-out visits
		●	●	●	●	Preventive maintenance visits 1-4 times per year
		●	●	●	●	Travel and labor for preventive maintenance visits
		●	●	●	●	Response time and priority on call-outs <24h
		●	●	●	●	Preventive planned maintenance that meets the most demanding standards in the market
	●	●	●	●	●	Safety and quality checks according to applicable regulations and norms. Documentation of test results provided
●	●	●	●	●	●	Documentation of equipment status, assessment and service provided, all generated on site
●	●	●	●	●	●	Highly trained professional technicians with extensive knowledge, state-of-the-art tools and the right spare parts*
●	●	●	●	●	●	Dedicated Professional Customer Care Hotline

● = Included as standard
○ = Available at special prices
* Well-stocked service vehicles with genuine and new spare parts

Index

Numerics

900 Door control systems	19
900 Door control systems - Selection guidelines	19
900 Door control systems - Selection guidelines for automation	20
920 Door control system	19
930 Door control system	19
950 Door control system	19

A

Access and automation	21
Additional functions	22
Air permeability	12
Automatic closing	22
Automatic control functions	21
Available Options	15

B

Balancing system	10
Basic control functions	21
Bottom seal	9
Building and space requirements	23
Building preparations	23

C

Cable break device (CBD)	10
CDM9 Operator	17
CDM9 Operator - 900 Door control systems	17
CEN Performance	11
Chain hoist	16
Colors	8
Construction	7
Copyright and Disclaimer Notice	2

D

Daylight width and daylight height	6
Description	6
Dimensions	6
Door leaf	7

E

Electrical operation	16
External control functions	21
External push button box	21

F

Features	3
Fixed sections	15

G

General	6, 13, 19
---------------	-----------

H

Handle	9
HHL - High lift with spring package at the end of the horizontal track	14
HL - High Lift	13

I

Installation preparations	23
Interlocking	21

L

Lifetime expectation	11
LL - Low Lift	13
Lock bolt	9

M

Magnetic loop	21
Material	7

N

Number of windows	15
-------------------------	----

O

Operating forces and safe openings	12
Operating system	16
Optional colours *	15

P

Performance	3
Photocell open door	21
Pull-down rope	16
Pull-rope switch	21

R

Radar	21
Reduced opening	21
Relay box	22
Remote control	21
Resistance to water penetration	11
Resistance to windload	11

S

SA/SH	8
Safety devices	10
Safety edge	22
Safety functions	22
Safety photocells 1-channel	22
Safety photocells 2-channel	22
Seals	8
Section sizes	6
Selection guidelines for door operator	18
Selection guidelines for operation type	17
Service	29
Side seal	8
SL - Standard Lift	13
SLL - Standard Low Lift	13
Space requirements	23
Space requirements HHL	26
Space requirements HL	25
Space requirements LL	27
Space requirements SL	24
Space requirements VL	28
Special track sets	14
Specifications	15
Spring break device (SBD)	10
Standard colours	8

T

Technical facts	3
Thermal transmittance	12
Top seal	8
Track sets	13
Traffic lights - Red & Green	22
Types of operation	16

U

UPS battery backup22

V

Vertical cross-section7

VL - Vertical Lift 14

W

Warning lights - Green22

Warning lights - Red22

Wind reinforcement truss9

Windows8, 15

ASSA ABLOY Entrance Systems is a leading supplier of entrance automation solutions for the efficient flow of goods and people. Building on the long-term success of the Besam, Crawford, Albany and Megadoor brands, we offer our solutions under the ASSA ABLOY brand. Our products and services are dedicated to satisfying end-user needs for safe, secure, convenient and sustainable operations.

ASSA ABLOY Entrance Systems is a division of ASSA ABLOY.

assaabloyentrance.com



ASSA ABLOY Entrance Systems

assaabloyentrance.com