

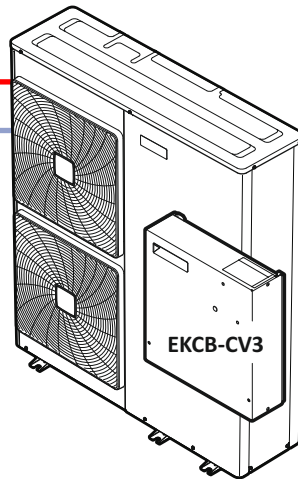

E-Pac 🛒 EKDVCPLT5H

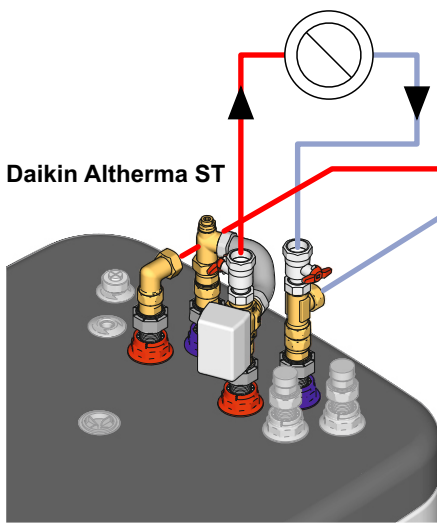

- DAIKIN Altherma M**
- EDLQ-CV3
 - EDLQ011-016CV3
 - EDLQ011-016CW1
 - EDLQ011-016C3V3
 - EDLQ011-016C3W1

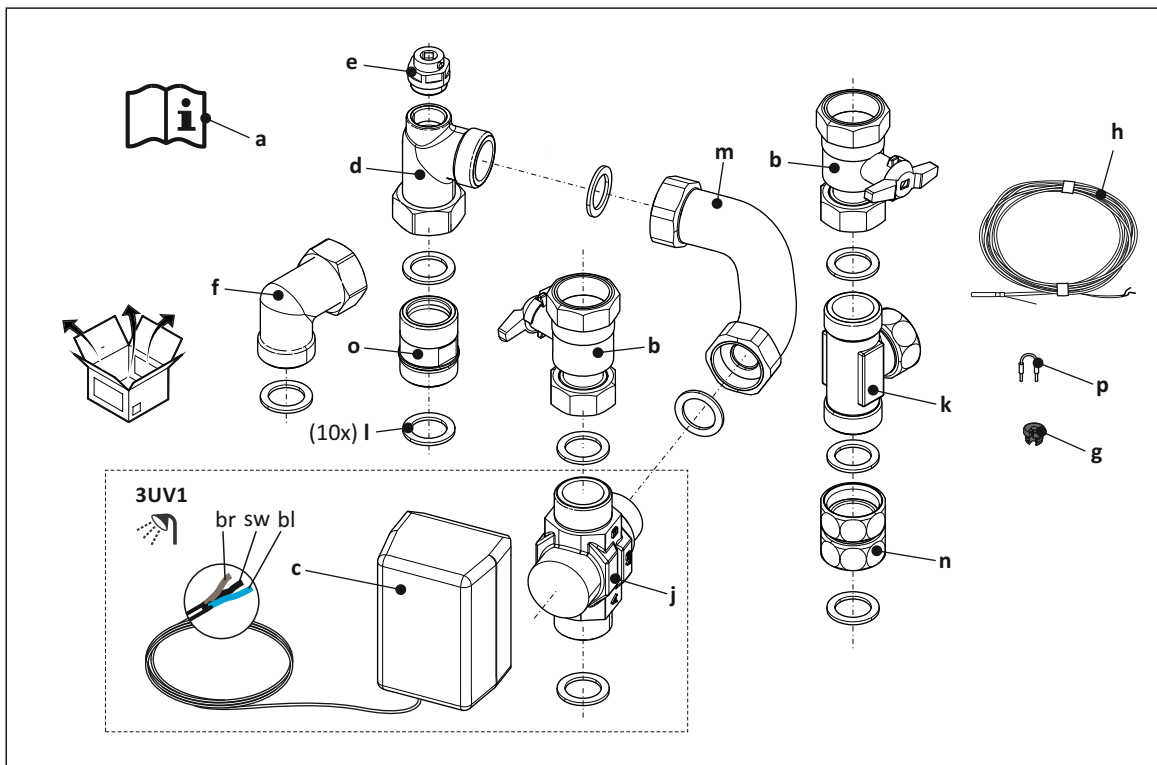

English
Deutsch
Français
Nederlands
Español
Italiano
Portugues



Daikin Altherma ST

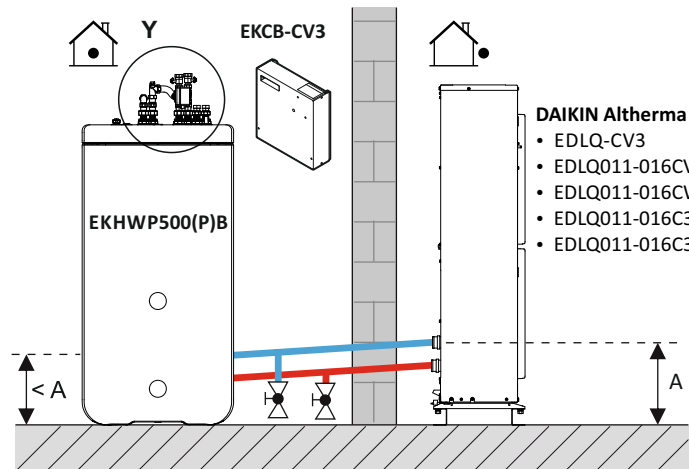
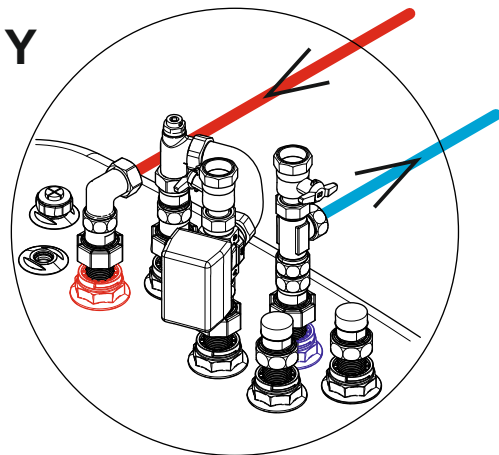
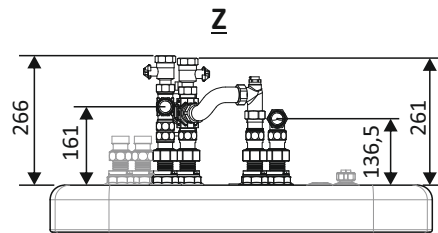
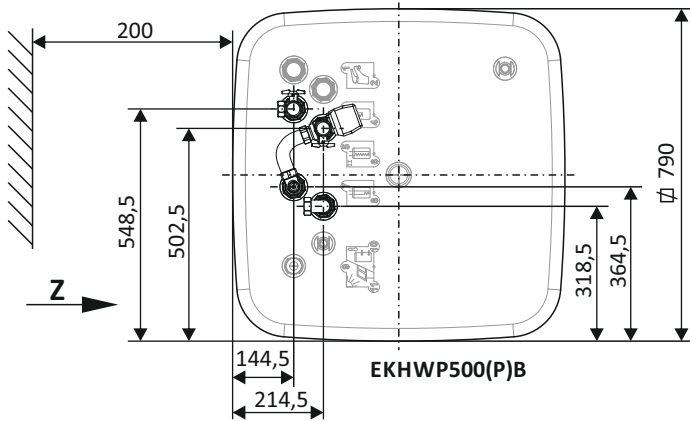
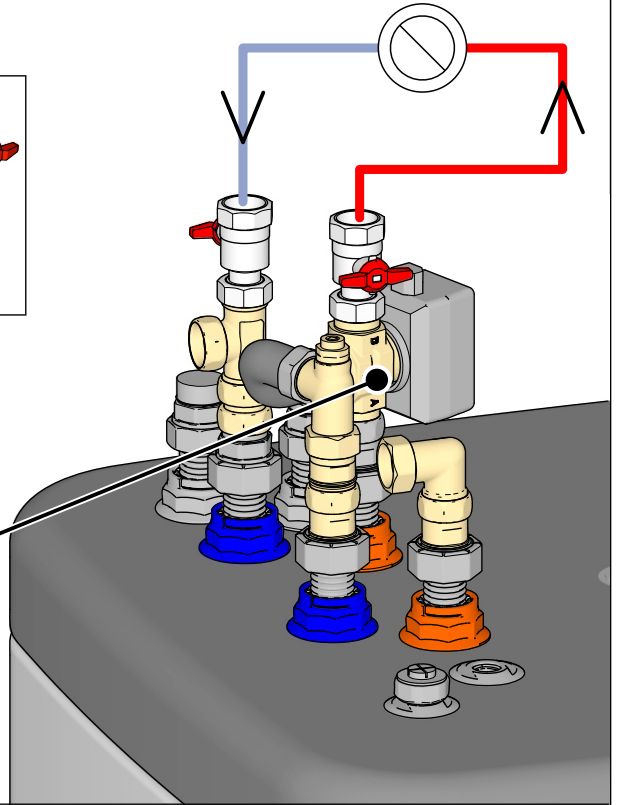
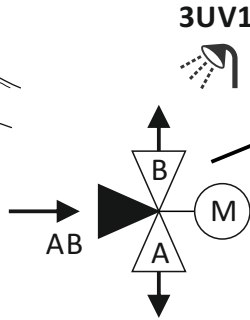
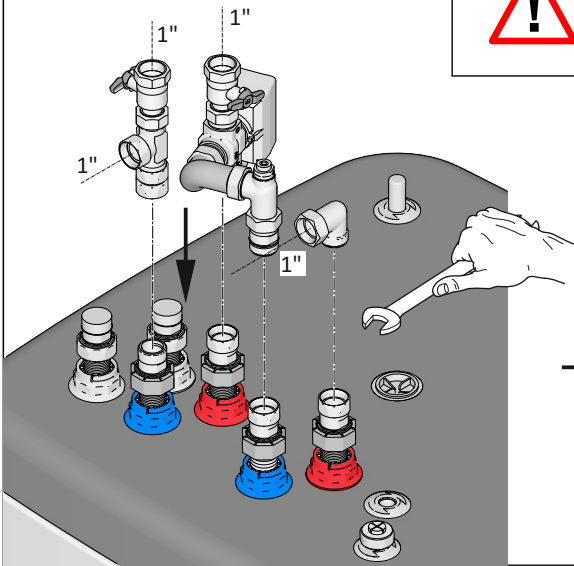
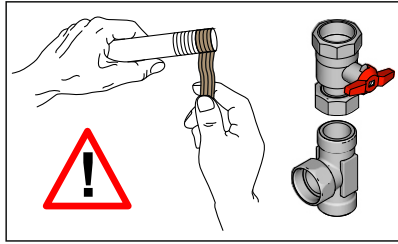

- DAIKIN Altherma M**
- EDLQ-CV3
 - EDLQ011-016CV3
 - EDLQ011-016CW1
 - EDLQ011-016C3V3
 - EDLQ011-016C3W1

	EN	DE	NL	IT	ES	FR	PT
br	brown	braun	bruin	marrone	marrón	marron	castanho
sw	black	schwarz	zwart	nero	negro	noir	preto
bl	blue	blau	blauw	blu	azul	bleu	azul

**DAIKIN Altherma M**

- EDLQ-CV3
- EDLQ011-016CV3

- EDLQ011-016CW1
- EDLQ011-016C3V3
- EDLQ011-016C3W1

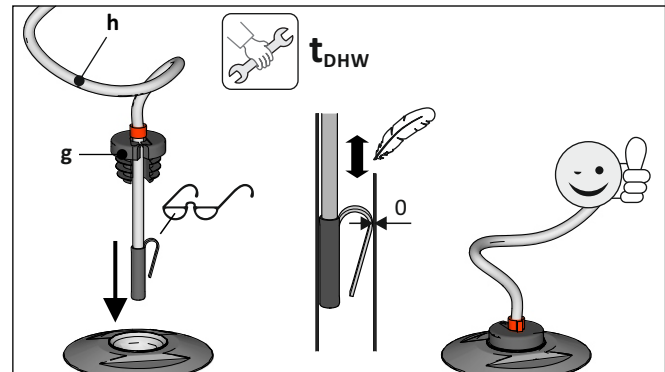
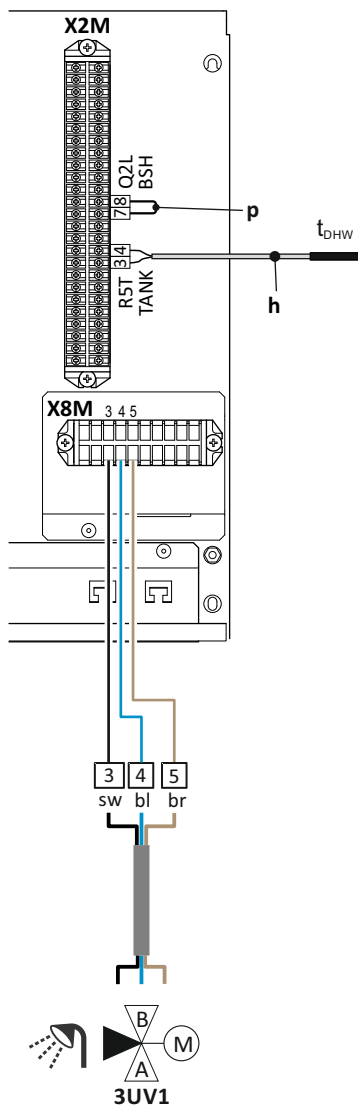
**Daikin Altherma ST
EKCB-CV3****EKCB-CV3**

	EN	DE	NL	IT	ES	FR	PT
3UV1	3-way-switch-valve	3-Wege Umschalt-ventil	3-wegs omschakel- klep	Valvolaa 3 vie	Válvula de conmutación de 3 vías	Soupape d'inversion à 3 voies	Válvula de comutação de 3 vias
t_{DHW}	Storage tank temperature sensor	Speicher- temperaturfühler	Opslagtemperatuur- sensor	Sonda di temperatura del bollitore	Sensor de temperatura de acumulador	Sonde de température de l'accumulateur	Sensor de temperatura do acumulador
EKCB-CV3	Control box for outdoor units with integrated hydraulic components	Steuerungskasten für Außengeräte mit integrierten hydraulischen Komponenten	Regelkast voor buitenunits met geïntegreerde hydraulische componenten	Scatola di controllo per unità esterne con componenti idraulici integrati	Caja de control para unidades exteriores con componentes hidráulicos integrados	Boîtier de commande pour unités extérieures avec composants hydrauliques intégrés	Caixa de controlo para unidades de exterior com componentes hidráulicos integrados
Daikin Altherma ST							
EKHWP 500(P)B	Hot water storage tank (500 l)	Warmwasser- speicher (500 l)	Warmwaterboiler (500 l)	Bollitore ad accumulo (500 l)	Acumulador de ACS (500 l)	Réservoir d'eau (500 l)	Acumulador de água quente sanitária (500 l)
EDLQ	Daikin Altherma M / outdoor unit						

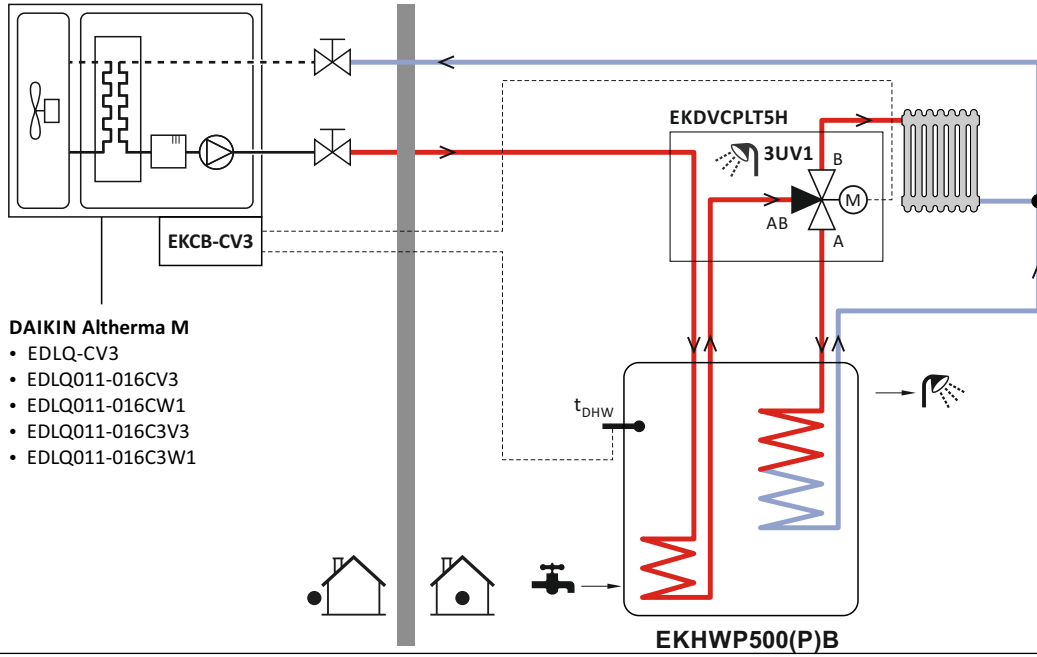

EDLQ + EKDVCPLT5H

EN	DE	NL	IT	ES	FR	PT	
Technical data	Technische Daten	Technische gegevens	Dati tecnici	Datos técnicos	Caractéristiques Techniques	Dados técnicos	
3UV1							
3-way-switch-valve	3-Wege Umschalt-ventil	3-wegs omschakelklep	Valvolva 3 vie (DHW)	Válvula de comutación de 3 vías	Soupape d'inversion à 3 voies	Válvula de comutação de 3 vias	
Operating voltage	Betriebsspannung	Bedrijfsspanning	Tensione d'esercizio	Tensión de servicio	Tension de fonctionnement	Tensão de serviço	230V / 50Hz
Maximum power input	Maximale Leistungsaufnahme	Maximale vermogens-opname	Potenza assorbibile massima	Absorción de máxima	Puissance absorbée maximum	Máx. consumo de corriente eléctrica	4,3 W
Protection type	Schutzart	Beschermingsklasse	Grado di protezione	Grado de protección	Type de protection	Tipo de proteção	IP 40
Turnaround time	Umschaltzeit	Omschakeltijd	Tempo di commutazione	Tiempo de conmutación	Temps d'inversion	Tempo de comutação	6s
KVS-coefficient	KVS-Wert	KVS-coëfficiënt	KVS-Coefficiente	KVS-coeficiente	KVS-valeur	KVS-valor	7,7
Storage tank sensor	Speicherfühler	Opslagtank sensor	Sensore accumulo	Sonda ACS	Sonde ballon	Sensor do acumulador	
R_s							
Resistance characteristics	Widerstandskennlinie	Weerstandskarakteristiek	Linea caratteristica	Curva característica	Caractéristiques de résistance	Linha característica	

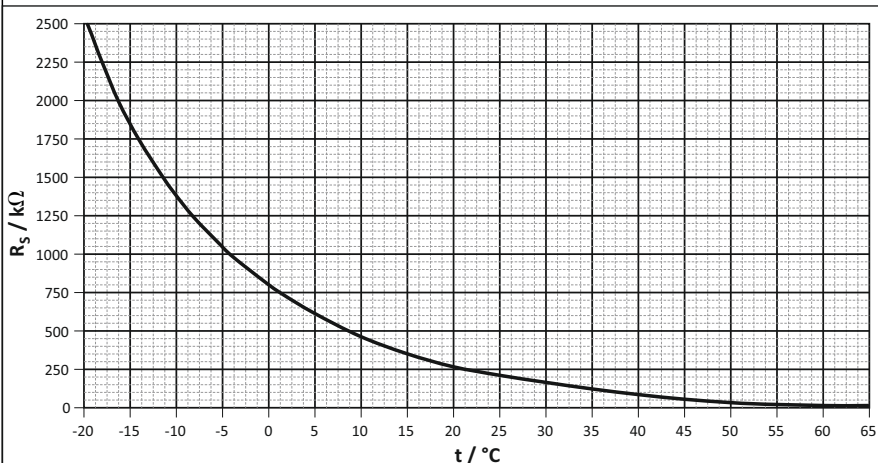

EDLQ + EKDVCPLT5H

DAIKIN EUROPE N.V.

Zandvoordestraat 300, B-8400 Oostende, Belgium

008.1448199 02 02/2020