

THE STRUCTURAL PROJECT SHOWCASE

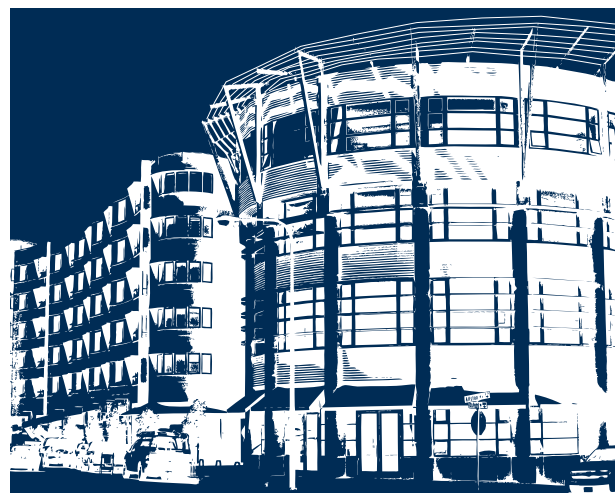

Outstanding infrastructure of the Be Inspired Awards

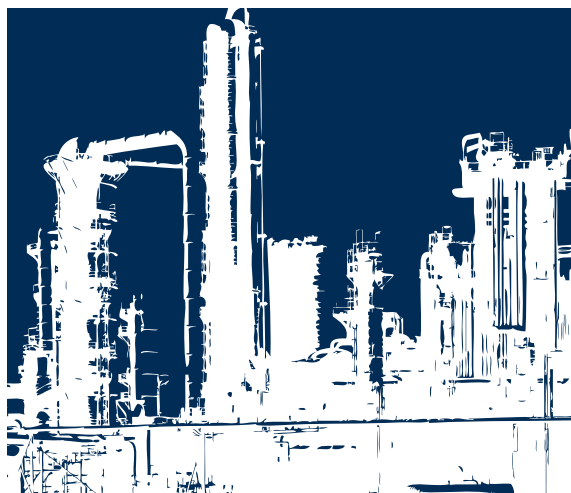
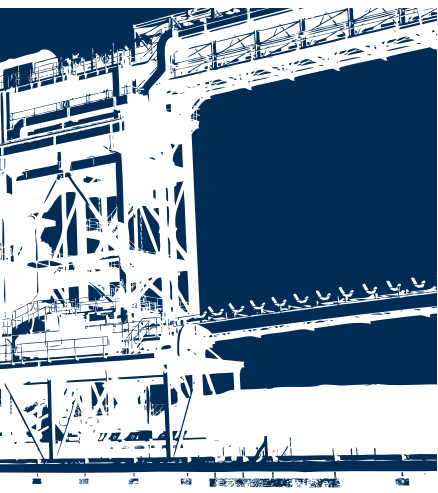
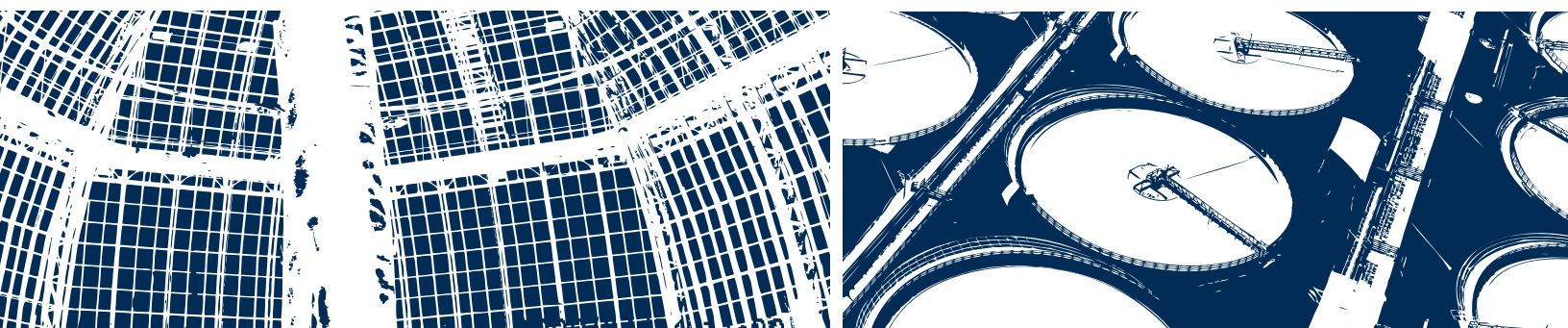
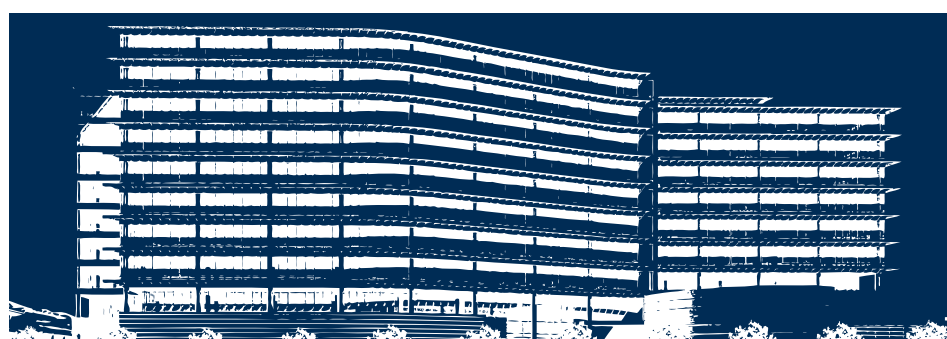
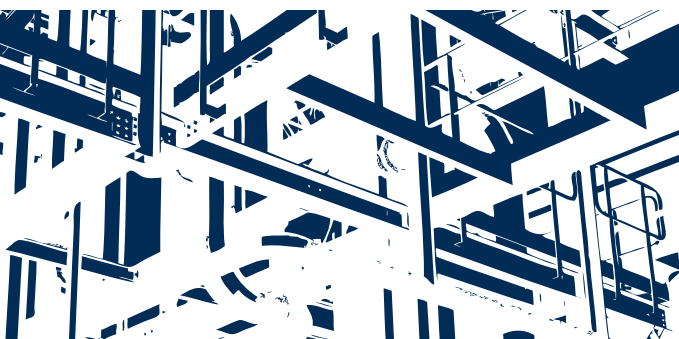

The Structural Project Showcase and *The Year in Infrastructure* series of publications are project yearbooks published by Bentley Systems, Incorporated that showcase the extraordinary work of Bentley users sustaining the world's infrastructure.

For information about how to enter your innovative project for consideration in the next Be Inspired Awards competition or for additional information about this program, visit www.bentley.com/BeInspired.

ONLINE VERSIONS

Digital versions of Be Inspired Awards publications are available online at www.bentley.com/YearInInfrastructure. Choose to view a specific issue or search within each issue using terms, titles, or keywords.

INFRASTRUCTURE AND INSPIRATION

The professionals who design, build, and operate infrastructure strive to improve the quality of life for people around the world—and that goal is what drives the amazing projects presented in *The Structural Project Showcase*. Within these pages you will find works of infrastructure that are inspirational on many levels: for the distances they span, the people they connect, the air and water they clean, and the renewable energy they produce.

These projects also represent tremendous innovation in the use of Bentley's integrated structural modeling to produce intelligent infrastructure that is measured in terms of operational efficiency, constructability, safety, and use of energy and nonrenewable resources. The projects you will read about here are state-of-the-art, employing Bentley's structural solutions to create new and sustainable value in every stage of the infrastructure lifecycle.

Bentley's **Integrated Structural Modeling** methodology maximizes the interoperability of structural information among different specialized applications, CAD and BIM platforms, and design reviews for all authors and consumers of a project's structural information.

Structural modeling, analysis, design, documentation, and detailing—within integrated and flexible workflows—empowers intelligent structural design practices.

The benefits are dynamic collaboration and increased data reuse among structural engineers, detailers, and fabricators. The results are more efficient delivery of high quality designs and well-coordinated and accurate documentation, along with increased project productivity, reduced errors, and improved quality control. Maintaining compatibility with architects and other disciplines extends these benefits across the entire project team.

The word *inspiration* is derived from the Latin "in" (into) and "spiro" (breathe). Indeed, the extraordinary projects that have been nominated for the **Be Inspired Awards** over the years that we proudly present are a breath of fresh air. They demonstrate our society's resilience in the face of tremendous challenges, both economic and environmental, and serve as a testament to the ability of engineers and architects, contractors, and owner/operators around the globe to solve any problem, great or small.

TABLE OF CONTENTS

| | |
|--|---------|
| BUILDINGS | 2 - 7 |
| CAMPUSES, AIRPORTS, AND MILITARY INSTALLATIONS | 8 - 9 |
| INDUSTRIAL FACILITIES | 9 - 11 |
| MINING AND METALS | 11 - 14 |
| OIL AND GAS | 14 - 19 |
| POWER GENERATION | 20 - 24 |
| STRUCTURAL ENGINEERING | 25 - 37 |
| WATER RESOURCES | 38 - 39 |
| <hr/> | |
| INDEX | |
| ALPHABETICAL BY ORGANIZATION | 40 |

BUILDINGS

Advanced technology aids in the delivery of high-performance buildings not only in terms of aesthetics, but also in areas of safety, energy savings, reduction of CO2 emissions, and compliance with regulations/accreditations. Today's building techniques also must demonstrate a clear return on investment. The projects in this category demonstrate excellence in planning, designing, building, modeling, analyzing, operating, and maintaining one or more buildings.

BUILDINGS

BDP

Teddington School

London, United Kingdom

The £34 million Teddington School in London fuses modern inspirational educational building design with innovative educational planning, organization, and teaching. It will replace the existing school where one of two hockey pitches was used for the new building site. As a result, the design strategy was to fit a sports hall, assembly areas, two teaching wings, an arts block, and a science block within the constraints of the existing hockey pitch.

Bentley Structural, Bentley Architecture, and STAAD.Pro brought significant project benefits. The 3D visualization formed the basis of communications with the client. The combination of 3D visualization and building information modeling allowed the design team to verify the structural solution. Combined with traditional MicroStation 2D drawings, these tools helped to inspire the client and illustrate the building form.

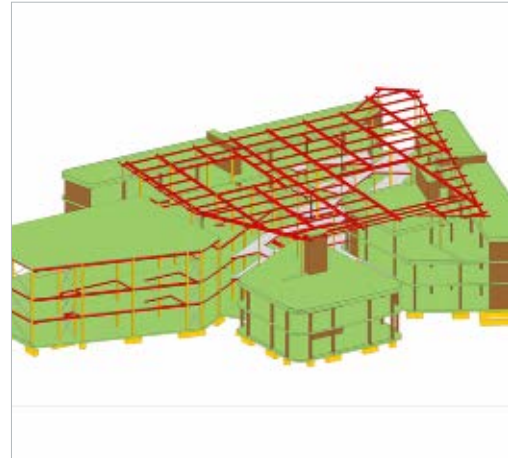

2009 FINALIST

DHV BV

Blaak 31 Residence Rotterdam City

Rotterdam, Netherlands

For the construction of a multistory residence at Blaak 31 in Rotterdam, architects needed to contend with a series of existing conditions that required careful planning and design, including the creation of a single-level car park below the building that would be located in close proximity to the city's metro tunnel.

MicroStation, TriForma, Bentley Structural, and STAAD.Pro were used to develop 3D models that generated both the necessary drawings and the figures underlying the calculations. The great advantage of this approach was the savings in time, with a consequent increase in design freedom and reduction in costs. Also, by providing material quantities in the model together with ground and frame plans and reports, the client could carry out calculations with greatly increased accuracy.

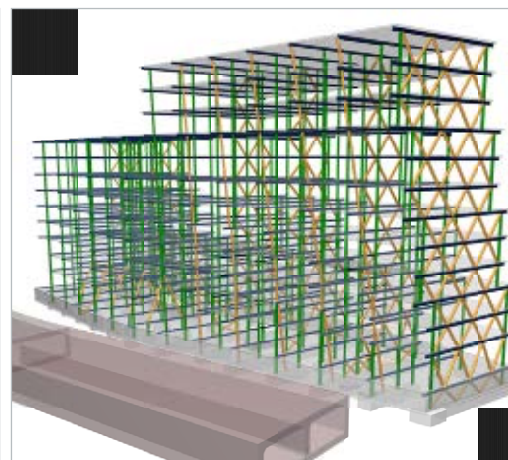

BUILDINGS

Fitzpatrick Engineering Group PLLC

Northeast Medical Center Acute Care Facility Expansion

Concord, North Carolina, United States

In response to greater demand and significant growth in use of its surgical facilities, the Northeast Medical Center located in Concord, N.C., proposed to modernize and consolidate its surgical inpatient and outpatient facility. The new surgery addition required demolition of existing site walls and relocation of existing mechanical ventilation while maintaining operation of the adjacent surgery suites.

BIM visualized complicated construction issues, produced construction documents, and shared information with the steel fabricator. RAM Steel and Bentley Structural allowed for tight integration between analysis software and drawing production and also empowered the engineers to leverage and extend their other analysis tools. The design team and contractor used MicroStation-generated 3D PDFs for visualization and clear communication of sequencing options.

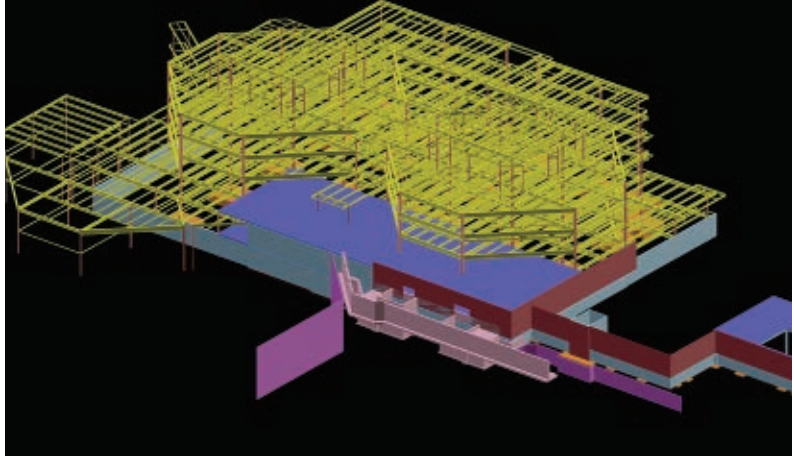
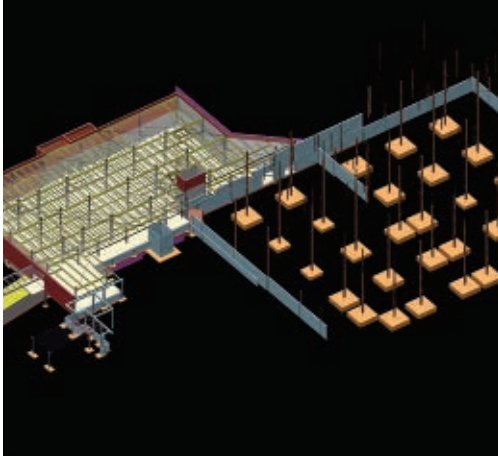

Flad Architects

Biotechnology Company—Fill/Finish Facility

Northwest United States

Seismic risk prompted this biotechnology company to relocate production to northwestern United States. Design, construction, and turnover of the new 300,000-square-foot, five-building facility was accomplished in 24 months. The aggressive schedule required a design team of more than 250 professionals worldwide. Through broadcast web meetings and conference calls, the team members coordinated design using BIM.

The \$400 million facility required an analysis tool that included seismic provisions, foundation design, connection design, and the ability to export into BIM software. RAM Structural System and RAM Connection enabled the engineering team to move with unprecedented speed and accuracy to stay ahead of the steel fabrication and construction schedule, meet the owner's aggressive schedule, and complete the project on time.



2009 FINALIST

Gresham, Smith and Partners Nissan Americas Corporate Facility Franklin, Tennessee, United States

When Nissan North America decided to relocate its operations in Gardena, Calif., to a new facility in Franklin, Tenn., Gresham, Smith and Partners (GS&P) was tasked with planning and designing the new facility. Since Nissan chose to move current operations to temporary office space while the new facility was being built, keeping the schedule on track was a crucial component.

But the aggressive schedule was not the only challenge GS&P had to overcome. It also had to maintain the budget and procure a specific type of steel within a short window of opportunity. To meet its commitments, GS&P turned to project-delivery process innovations. To save time and reduce errors during design, GS&P used the intra-operability features of RAM Structural System and TriForma to automatically generate the structural steel framing plans for the entire building.

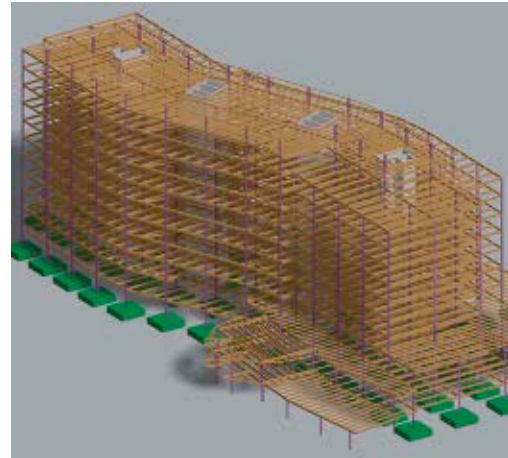

Korda/Nemeth Engineering Inc Ithaca College Athletics and Events Center Ithaca, New York, United States

The \$52 million Ithaca College Athletics and Events Center features a 130,000-square-foot field house and 35,000-square-foot aquatic pavilion. Fresh air for the field house will be provided without electricity by utilizing a 180-foot-tall natural ventilation tower—one of the sustainable design features that may qualify the building for LEED-Gold certification.

The design team separated the field house into two RAM Structural System models. The design load analysis was supplemented in RAM Advance (now RAM Elements) to ensure accurate results. The link between RAM Structural System and RAM Advance proved to be valuable when Phase 2 construction of the aquatic pavilion was moved to Phase 1. The design team revised the mechanical systems for both facilities to achieve a more efficient layout.

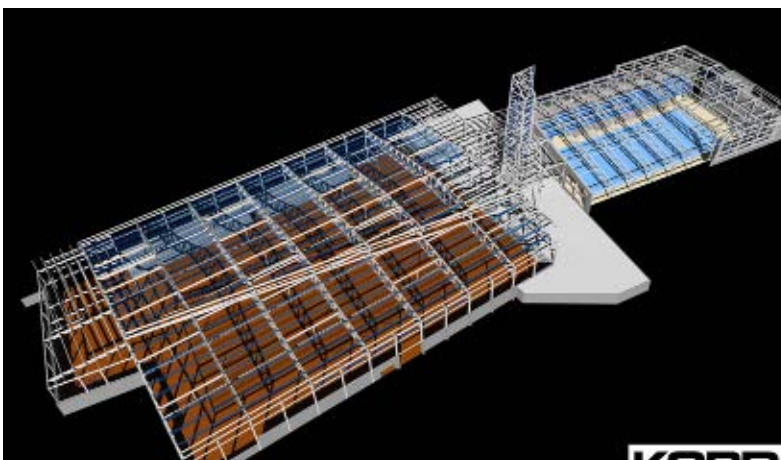

BUILDINGS

NBBJ and Korda/Nemeth

Glickman Tower

Cleveland, Ohio, United States

The Glickman Tower is a 325,000 square-foot outpatient building on the main campus of the Cleveland Clinic near downtown Cleveland, Ohio. The project consists of 10 above-grade habitable floors, a habitable basement, and a two-story mechanical penthouse topped by a helipad. The largest challenge was the extremely fast track of the project, which needed to be completed simultaneously with a building that entered design more than four years earlier.

Because of the need for speed and efficiency, the decision was made to use BIM—specifically, the TriForma extension of MicroStation, Bentley Structural, and Bentley’s RAM product line. Bentley’s integrated BIM solutions were chosen because they provided the ability to extract 2D drawings from a 3D model as well as a robust rendering engine, and support a collaborative team environment.



2007 FINALIST

PARADIGM Structural Engineers, Inc.

Virginia Data Center 6

Ashburn, Virginia, United States

This \$78 million LEED-certified data center in Ashburn, Va., is designed to remain fully functional—ensuring zero downtime for servers—during and after a seismic event. The building is the sister to a data center designed for the same owner in another region. Although the first building has different seismic tolerances, the project team was able to reuse the previous RAM model.

Working with new seismic parameters, the design team used RAM Structural System to do multiple iterations of the model and optimize steel sections and structural framing. This not only reduced engineering hours but also ensured that the client would not waste construction costs on unnecessary steel and building materials. Bentley software helped the team achieve the building’s mission-critical criteria in the most cost-effective way.



Structural Affiliates International, Inc.

Torre Planetarium

Panama City, Panama

The Torre Planetarium condominium building in Panama City reinforces the concept of steel as an efficient and economic building material for high-rise construction. The adjoining towers add height and character to the skyline. Conveying geometric concepts and details to the architect's office in Panama from Structural Affiliates' home office in Nashville, Tenn., became the main challenge.

Bentley's RAM Structural System allowed the transfer of visual concepts reinforced with 3D models. The software enabled coordination of documents between the Tennessee and Panama City offices and allowed export of 2D plans and elevations, and complete structural element CIS/2 files for geometric coordination to prevent spatial conflicts. RAM Structural System generated an out-of-core solution engine to model unique design elements.

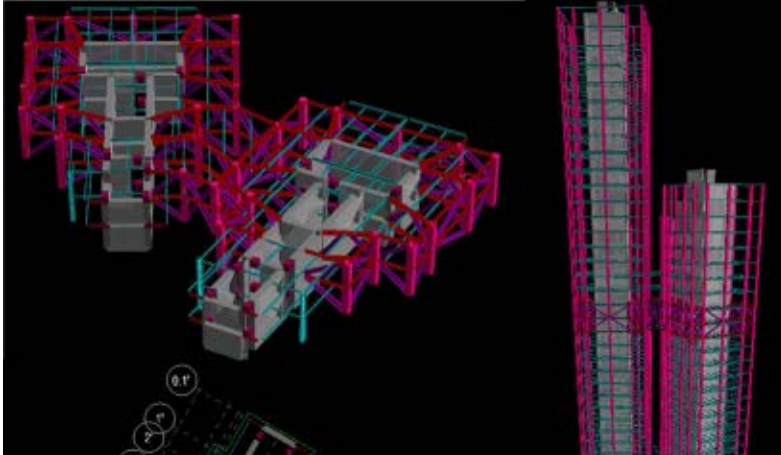

Tipping Mar

The David Brower Center

Berkeley, California, United States

This \$74 million mixed-use building in downtown Berkeley, Calif., reflects the city's commitment to environmental stewardship and affordable, accessible housing for all its citizens. The LEED Platinum-targeted David Brower Center provides offices for nonprofit environmental organizations, while Oxford Plaza Housing provides 97 housing units with rooftop gardens and children's play areas.

The ambitious environmental sustainability goals required close collaboration among the project architect, engineer, developer, and contractor to integrate the structural system into an intricately configured building with unique daylighting and HVAC requirements. Located less than a mile from the Hayward Fault, the project also set ambitious seismic performance goals. RAM Concept proved essential in designing for the seismic collector loads.

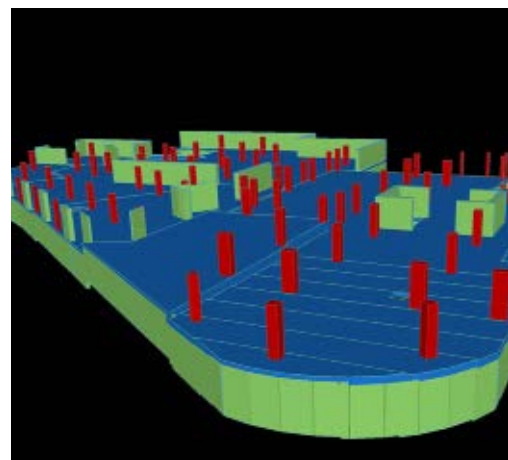

CAMPUSES, AIRPORTS, AND MILITARY INSTALLATIONS

Managing information about facilities, assets, and users requires information authored in many systems by many people over time. A digital model facilitates design collaboration, supports construction delivery, and leverages facility information for operations and maintenance. This category celebrates innovative approaches to design, construction, and operation of all types of campuses, airports, and military installations.

Barge Waggoner Sumner & Cannon, Inc.

AFRC and Army Reserve Program Regional Support Command Headquarters

Mountain View, California, United States

This \$78.5 million project revitalized a decommissioned military facility at Moffett Field in Mountain View, Calif. After abandoned military housing was demolished, the site was developed for a new Army Reserve Center and Regional Sustainment Command Headquarters. The facility also serves as an Emergency Management Center for the California National Guard. The project included three buildings totaling 270,000 square feet and associated site improvements.

Barge Waggoner Sumner & Cannon used Bentley building, civil, and structural solutions to produce three design packages. The distributed design capabilities inherent in Bentley's building information modeling software enabled a design team of more than 70 people to work in parallel on all aspects of the project, saving design time and shortening the project duration.



2009 FINALIST

Mehro Consultants

NSCBI Integrated Terminal Building, Kolkata Airport

Kolkata, India

Phase 1 expansion of the NSCBI Airport in Kolkata, India, includes a 3-million-square-foot terminal building designed to handle peak flow of 1,800 passengers per hour, which will then double with Phase 2 expansion. The building is designed with open, column-free spaces that allow passengers to pass easily from roadway to aircraft. Upon completion, NSCBI will be a major transport hub for eastern India.

The main challenge of Phase 1 was to design a steel roof spanning up to 99 meters—with a cantilever span of 27 meters—while simultaneously allowing natural light to flood the interior. The project team deployed STAAD.Pro to rapidly experiment with various design solutions. The most economical solution turned out to be a trapezium-shaped steel truss with high-strength structural steel.

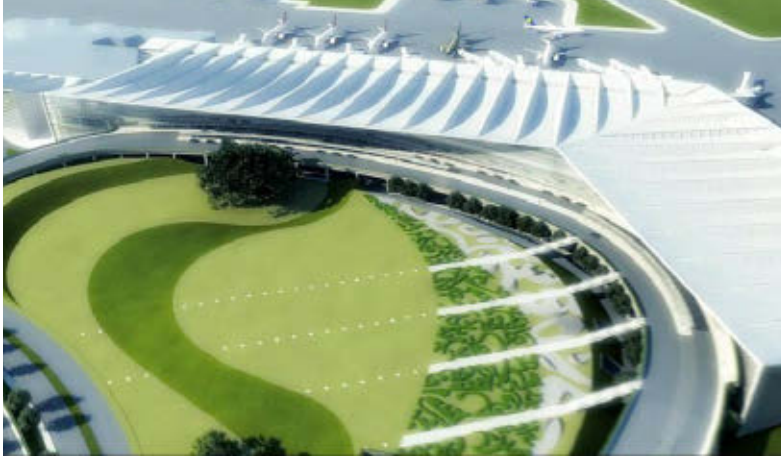

INDUSTRIAL FACILITIES

Flexible and highly scalable industrial facilities are fundamental to further improvements in production and revenue, whether the facilities are new factories or the reconstruction of existing facilities. Maintaining profitability requires the control of costs throughout the entire lifecycle: design, construction, operation, and renewal. This category honors innovative networks of models, methodologies, and toolboxes that integrate the planning and design of industrial facilities with the manufacturing process.

INDUSTRIAL FACILITIES

Alstom Projects India Limited

Tan Jun Bin

Kolkata, India

The primary goal of this project was to calculate the stress and deflection of a large duct to assess its structural profile and confirm its plate thickness. Modeling proved difficult because three inside chambers required baffle plates for flow distribution. Without including these details, the project team initially had a difficult time limiting deflection values.

Using STAAD.Pro, Alstom achieved expected results after conducting several trials with mesh generations and stiffener location optimization. Deploying Bentley's integrated solutions gave Alstom the ability to manage the project within the given timeframe and budget, which resulted in a higher return on investment.

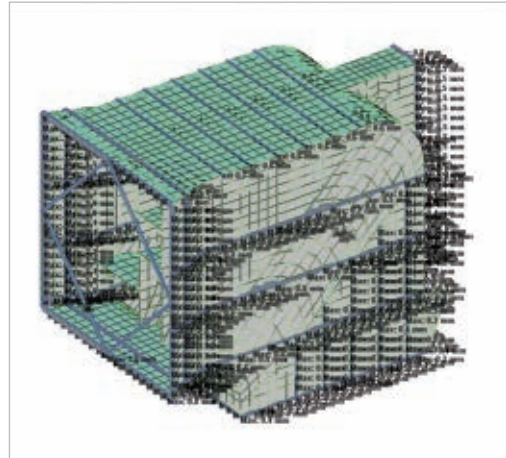
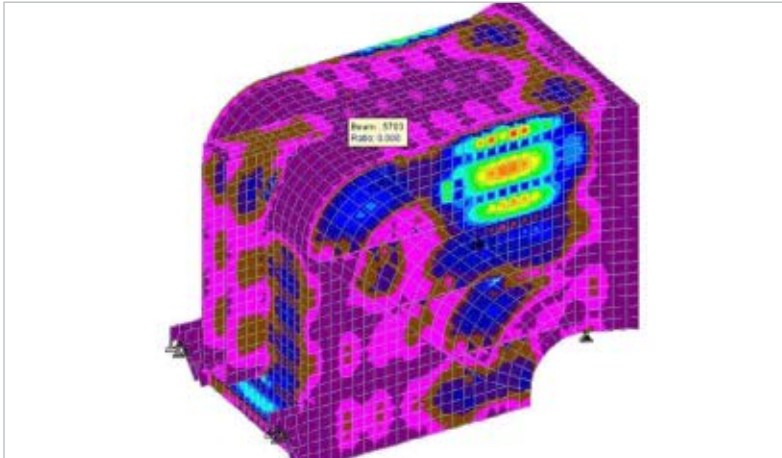

GHAFARI Associates, LLC and General Motors

3D Enabled—Plant Expansion at the General Motors Toledo Powertrain Transmission Plant

Toledo, Ohio, United States

General Motors expanded its Toledo, Ohio, transmission plant to produce a new automatic transmission for full-size SUVs and trucks. The project includes 275,000 square feet of facility renovation and 475,000 square feet of new construction. GHAFARI's design-build team was able to push 3D-enabled delivery to levels beyond what was achieved on previous projects.

GHAFARI used 3D laser scanning to capture existing conditions. To avoid spending weeks converting these scans into 3D models, GHAFARI utilized Bentley CloudWorx and TriForma to link the point clouds into the model. The hybrid model was used to accelerate decision making and coordinate demolition sequences, saving hundreds of hours of delays in the process.

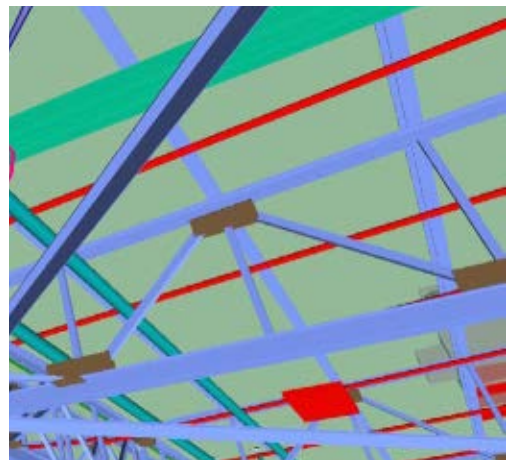
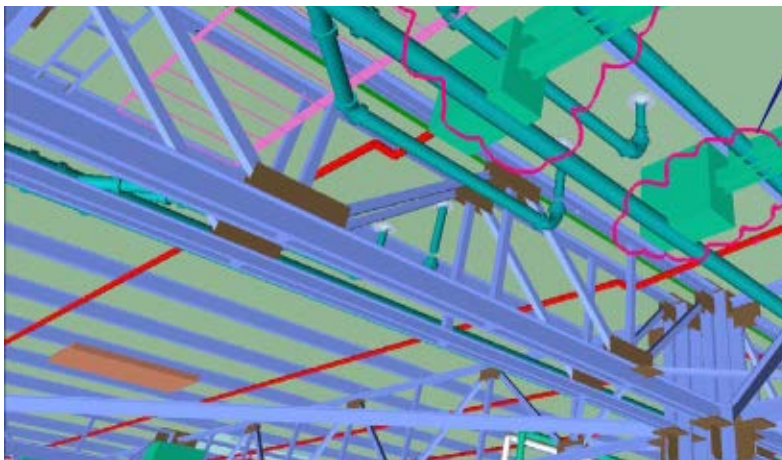

2008 FINALIST

This multifaceted project involved designing several industrial structures, including a coal drying unit, acid recovery plant, and refractory shed. The primary challenge facing the design team was finding an alternative to manual drawing methods for multiple load parameter and design iterations when performing client-requested changes.

Using STAAD.Pro, load data and foundation design parameters for various units were compiled. The structural frames were then analyzed for seismic load bearings. Using AutoPLANT's 3D modeling capabilities, engineers developed the steel members and produced shop drawings of the layout beams, columns, and bracings based on customer specifications. Bentley 3D modeling software saved approximately 25 percent man-hours over the course of the design.



MINING AND METALS

Mining and metals professionals strive to shorten project schedules and lower operating costs through improved access to mission-critical information. The projects in this category used technology to demonstrate both short-term and long-term benefits that increased the efficiency of capital projects associated with the engineering, construction, and operations of mines and metals processing and refining plants.

MINING AND METALS

Bateman Engineering Pty Ltd

Karara Iron Ore Project

Perth, Australia

Located 256 kilometers inland in remote Western Australia, the AU \$1.8 billion Karara Iron Ore Project will bring industry to an undeveloped area upon completion in 2010, creating new employment opportunities and attracting overseas business to Australia. Bateman Engineering delivered the 30 percent front-end engineering design to the Maison Worley Parsons office in Beijing, China, where the project was taken for final design.

Multiple consultants using different CAD systems all fed into the common office. Using Bentley Structural for the main design work allowed the export of models to STAAD.Pro for transmission and the import of changed models back into Bentley Structural. Data was transmitted digitally as general arrangement drawings, STAAD.Pro models, and rendered images. When Australian steel sections had to be changed to Chinese steel sections midway through the project, it was a simple matter to update the steel members.

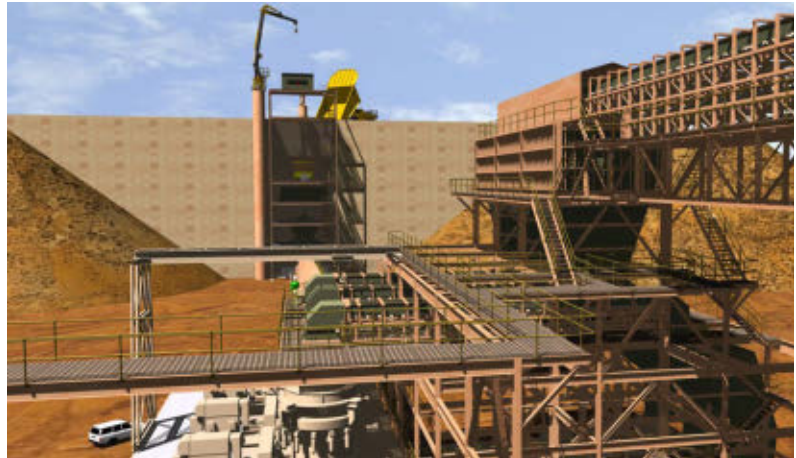

MECON Limited

262 Cubic-Meter Blast Furnace Complex

Karnataka, India

The scope of work involved in designing this 262-cubic-meter blast furnace complex for Kalyani Steels Limited was daunting. For MECON Limited to design a hot-blast system, blast furnace with cast house, gas cleaning plant, dust catcher, material feeding system, and interplant pipelines, it required working seamlessly across a multidiscipline design team.

To accomplish this task, MECON deployed the interoperable capabilities of Bentley products, including AutoPLANT, AutoPIPE, and STAAD.Pro to produce a 3D model of the complex. The Bentley tools enabled MECON to export the 3D model to other CAD modeling software quickly and easily. Indeed, Bentley solutions were especially beneficial for shortening the design schedule and producing flawless deliverables.

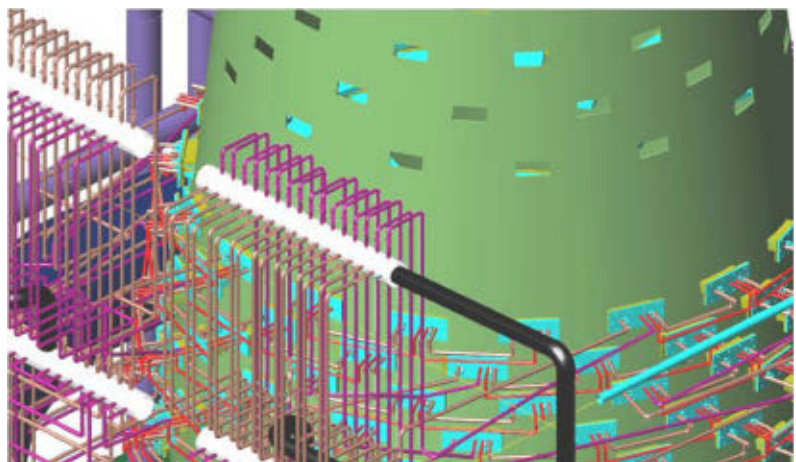
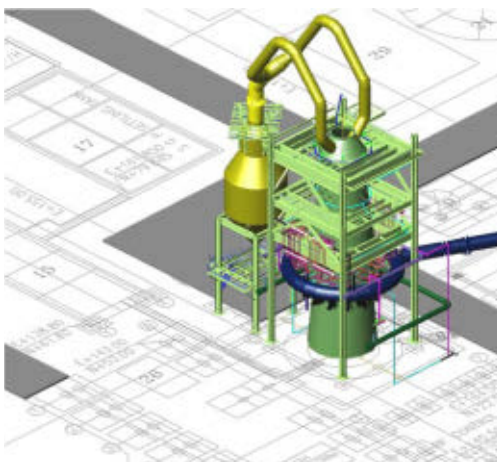

MINING AND METALS

PDC Consultants

BHPB Rapid-Growth Project Newman Hub

Perth, Australia

BHP Billiton retained PDC Consultants to provide mine information modeling with intelligent 3D review models and shop detailing for more than 8,000 tons of mechanical and structural steel and associated platework at the Newman Hub near Perth, Australia. The expanded mining operations will include a car dumping facility, crushing and screening plant, coarse ore stock pile, stockyard, train load-out facility, 12 conveyors and transfer stations, and associated infrastructure.

ProSteel was used to model and detail complex mechanical items, including bins, curved trusses, transfer chutes, and liner systems. By enabling collaboration across the project lifecycle, the software helped reduce the estimated modeling and detailing man-hours by 10 to 20 percent and allowed PDC to exceed the client's aggressive schedule by finishing three to four months earlier than expected.



2009 FINALIST

PDC Consultants

Pilbara Iron Ore and Infrastructure Project—Cloudbreak Ore Handling

Pilbara, Australia

Cloudbreak, an open-access port, rail infrastructure, and first mine site in western Australia, needed more than 10,000 tons of steel to construct a screening building, 11 product and scalping screening bins, crushing building, train loading dock, and 11 conveyors and associated transfer stations. PDC Consultants deployed ProSteel software as its viewing tool and BIM solution.

The software was used to model and detail the more complex mechanical items, including bins, curved trusses, transfer chutes, and liner systems. The PDC design team involved itself early in the process to help overcome time and labor constraints by speeding the design and detailing stages. The design team completed Cloudbreak in two years and the mine scheduled its first ore shipment for May 2008.

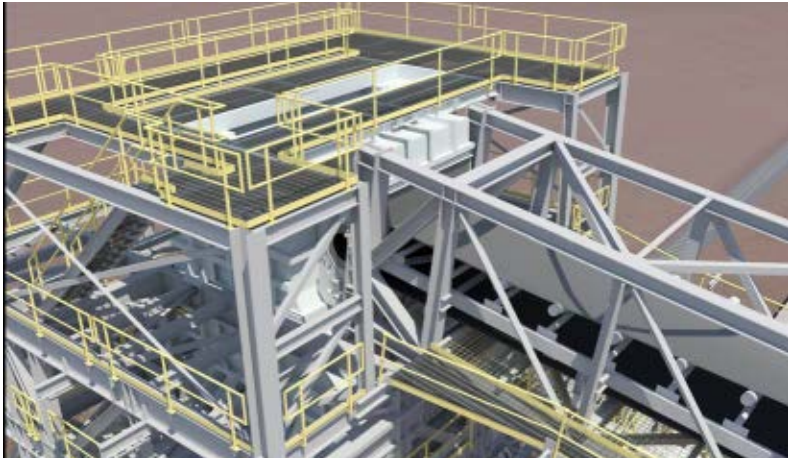

MINING AND METALS

Quotient Engineering Inc.

Utkal Alumina Liquor Evaporation Project

Rayagada, India

Utkal Alumina International Limited is installing an evaporation plant at its Alumina Refinery facility as part of a 1.5 million-ton-per-annum aluminum refinery in the state of Orissa on the eastern coast of India. The plant will provide direct and indirect employment to the region and improve the quality of life for about 5 million people.

Quotient Engineering lacked a provision for defining the line design parameters, which were required to appear in the line isometrics. Additionally, Quotient Engineering's third-party graphics for pipe supports could not be customized per the client's request. Through its use of AutoPLANT and STAAD, the design team was able to read design parameters from the line list, customize a support graphics library, reduce man-hours, and limit human error.

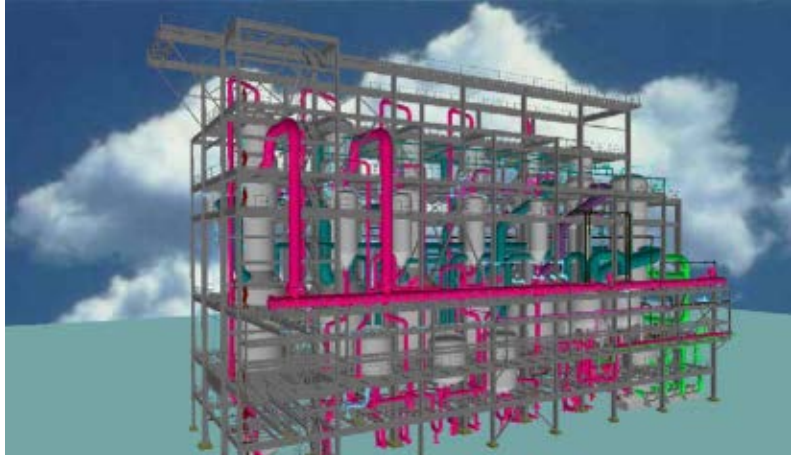
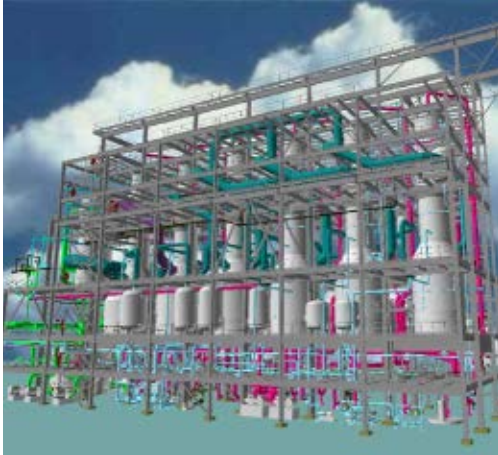

OIL AND GAS

When designing, constructing, managing, and operating upstream and downstream oil and gas production facilities, the management of crucial information throughout the lifecycle is critical. This category covers a wide range of technological innovation in the oil and gas industry ranging from mapping the fields and preparing new drill-site locations to the design, construction, operations, and maintenance of gas processing plants, oil production facilities, and complex refineries.

Dr.techn.Olav Olsen a.s.

MPU Heavy Lifter

Oslo and Sandefjord, Norway

The MPU Heavy Lifter, a concrete hull structure in Norway outfitted with lifting frames, steel decks, and living quarters, will enable offshore topsides and jackets to be transported in one piece, minimizing offshore work when installing or removing such platforms. The heavily pre-stressed structure must have all penetrations and embedded items in place before placing the concrete.

Using Bentley Structural, the team created data groups that tracked 4,500 embedded items and 105,000 kilometers of ducts. Each embedded item has data group information such as type, reference to design drawing, attachment purpose, attachment profile, and design loads/support reactions. This information is tracked in construction lists along with the coordinates of each item so the contractor can place them in the concrete structure without interference.

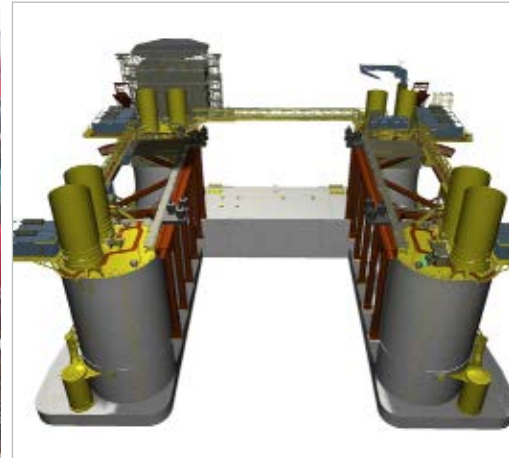

Hatch

Feasibility Study of El Lajjun Oil Shale Project

El Lajjun, Jordan

Hatch's regional office in Calgary, Canada, was retained to conduct a feasibility study and conceptual design for the El Lajjun Oil Shale Project in El Lajjun, Jordan. Based on the 30 percent complete design, the project team rapidly produced a cost estimate. Accurate material take-offs were automatically generated from the models.

Hatch deployed PlantWise, PlantSpace, Bentley Structural, and InRoads for design and Bentley Navigator for design reviews. PlantWise enabled the project team to produce accurate MTOs and plot plans at a point in the design phase when that level of detail is not typically required or expected.



OIL AND GAS

Koksoprojekt Spolka z o.o.

Plant for Deacidification and Ammonia Desorption

Krakow, Poland

The primary goal of the project was to design a modern plant in Krakow, Poland, for deacidification and ammonia desorption from process water. Koksoprojekt saved significant time by implementing 3D modeling. The relatively small size of data files and drawings provided the capability to efficiently analyze the model and avoid possible clashes, improving the quality of work and reducing the cost of erection.

Enabled by AutoPLANT, AutoPIPE, ProSteel, and ProjectWise, the firm avoided costly mistakes, better synchronized the multistage project preparation process, and gained a higher overall quality at a lower cost. The total project was completed in four months, as compared to the typical time frame for this kind of project of about 12 months.

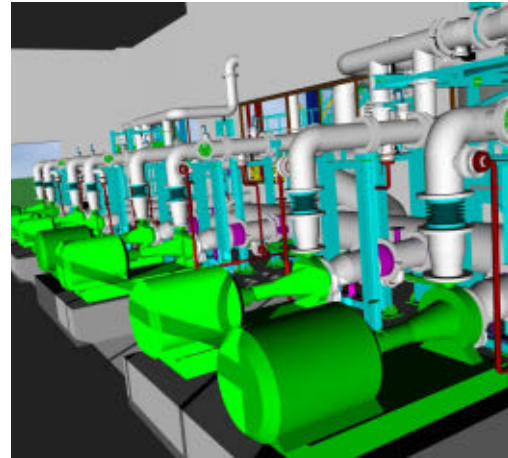

Koksoprojekt Spolka z o.o.

Plant for Ammonia Catalytic Degradation and the Claus-Method Sulfur Production in Unit of the Coke Plant "Przyjazn"

Dabrowa Gornicza, Poland

With a focus on modern ecological solutions, Koksoprojekt Spolka designed and engineered this coke-oven gas purification project. This multidiscipline assignment required extensive knowledge of specific industry technology. Additionally, all the design objects were vast and extremely complicated. Successful project completion relied on Koksoprojekt's ability to ensure P&ID and model synchronization.

Using AutoPLANT 2D to 3D software, the design team could trace the contents of the P&ID diagrams while building the 3D model. The software also helped the team to identify clash detection and produce high-quality isometric documentation. Bentley's integrated CAD software helped Koksoprojekt achieve its goals, improve the quality of the undertaking, and complete the project quickly.

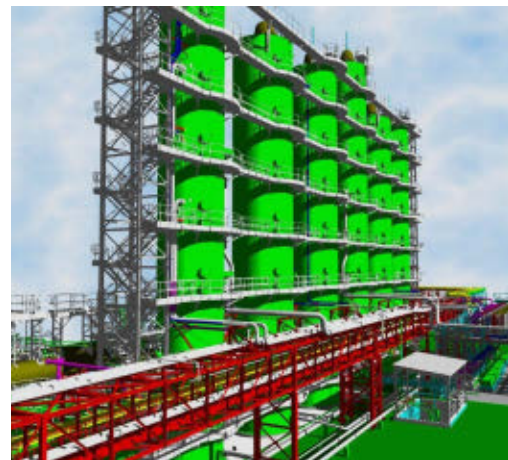
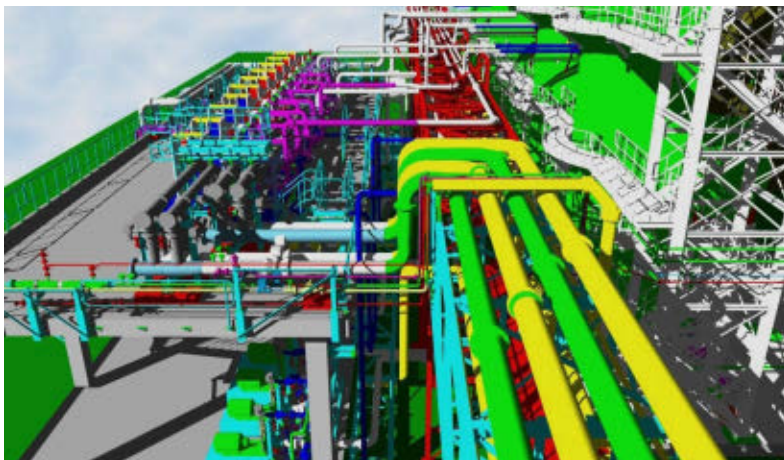

L-Con Engineers and Constructors

Dynamic Fuels

Geismar, Louisiana, United States

Dynamic Fuels, a joint venture of Tyson Foods and Syntroleum, retained L-Con Engineers and Constructors to design and build the nation's first synthetic renewable fuels plant, converting fats, oils, and greases into high-quality fuels as well as synthetic jet fuel. The \$138 million project location is a decommissioned and abandoned plant in Geismar, La.

Based on old drawings, soil reports, photos, and surveys, a 3D model was created using AutoPLANT and MicroStation. Verifying and engineering was done with STAAD.Pro and STAAD.foundation, and AutoPLANT Piping and ProSteel were used to complete the 3D visualization. All disciplines were combined in one 3D model so that during model review, using ProjectWise Navigator, all changes were evaluated for value, cost, and functionality.

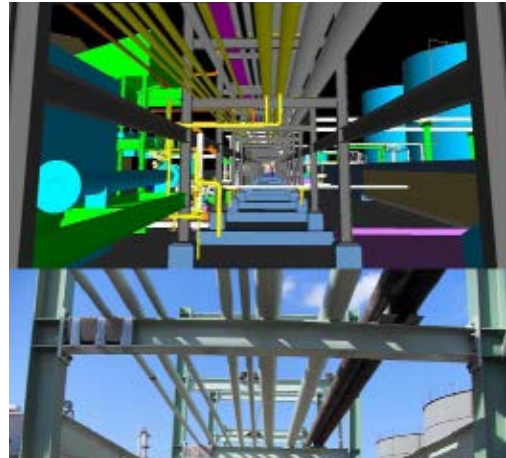

Nafta-Gaz Sp. z o.o.

Natural Gas Deposits Arrangement

Wielichowo, Poland

The primary goal of this multidisciplinary project in Wielichowo, Poland, was to provide arrangement of the natural gas deposits. Numerous challenges arose during the design process, but Bentley technology enabled Nafta-Gaz to overcome them. For example, corrections and modifications required by the customer were incorporated without introducing human errors.

The 3D model delivered automatic updates of critical data and drawings during successive documentation releases. Significant time was also saved due to 3D modeling capabilities, and reliable documentation was automatically generated rapidly and error free. AutoPLANT P&ID, AutoPLANT Piping, AutoPLANT Equipment, AutoPLANT Vision, ProSteel, Bentley View, ProjectWise Explorer, and ProjectWise Navigator were used in this project.



OIL AND GAS

Nafta-Gaz Sp. z o.o.

Natural Gas Well Arrangement

Roszkow, Poland

The main goal of this project in Roszkow, Poland, was to design the arrangement of the new natural gas well. AutoPLANT, ProSteel, Bentley Vision, and ProjectWise Navigator delivered a 50 percent time savings.

A centralized project database for P&ID data storage and a 3D physical model workout was implemented. The database was then used for isometrics generation and the AutoPLANT database was configured to store all documents referring to this project so they were available through the networking environment within the company.

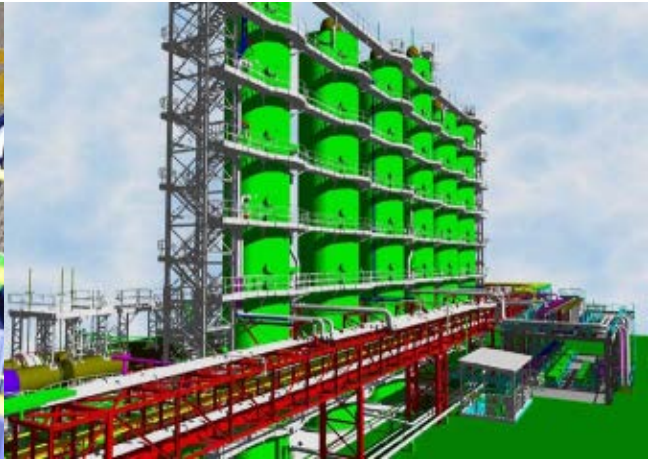
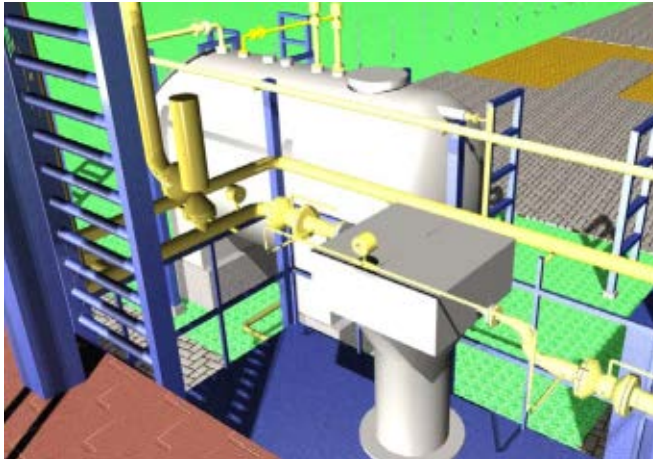

NK Rosneft–NTC

VNK1

Krasnoyarsk, Russia

As part of a major Siberian oil field development project, this project encompassed the development of an oil processing facility in the Krasnoyarsk territory. The facility will be one of the largest crude extraction and processing plants in Siberia, Russia.

To optimize team performance, engineers and subcontractors from various disciplines were trained to use Bentley products. AutoPIPE and AutoPLANT allowed simultaneous model development among disciplines and enabled fast design reviews. Bentley products minimized project development time and improved overall project quality.

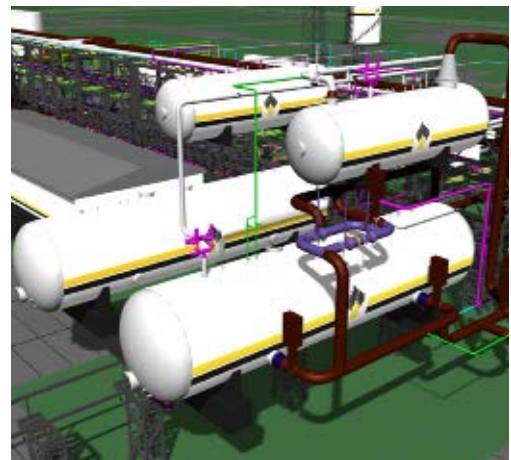

Petrochim Engineering Crystalliser Disk Regenerativ Orsk and Kstovo, Russia

Russian firm Petrochim Engineering, in cooperation with Israel-based Yutec Technologies, designed a disk-type crystallizer for a dewaxing unit to obtain higher quality oils to meet strict emission regulations. The goals were to reduce overall dimensions, ensure soundless unit operation, and define loads on vessel body and internals with maximum accuracy.

AutoPIPE designed the crystallizer components, reduced vessel dimensions, and defined optimum locations for disks and supports on the eight-meter bearing hollow shaft. Using this software for calculation of forces due to external loads also accelerated design. The new unit increased dewaxed oil yield by 3 to 4 percent and decreased oil content in slack wax by 30 percent. Harmful solvent leaks were completely eliminated, and noise was considerably reduced.

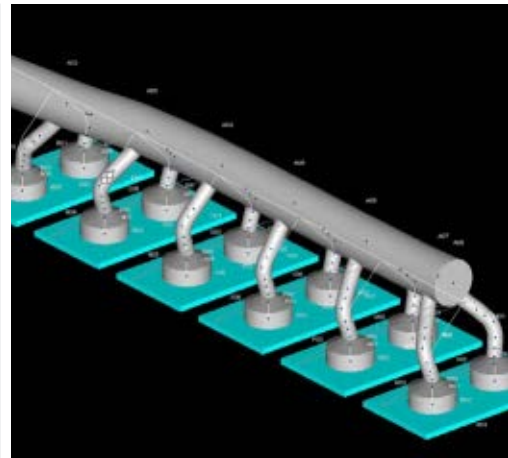
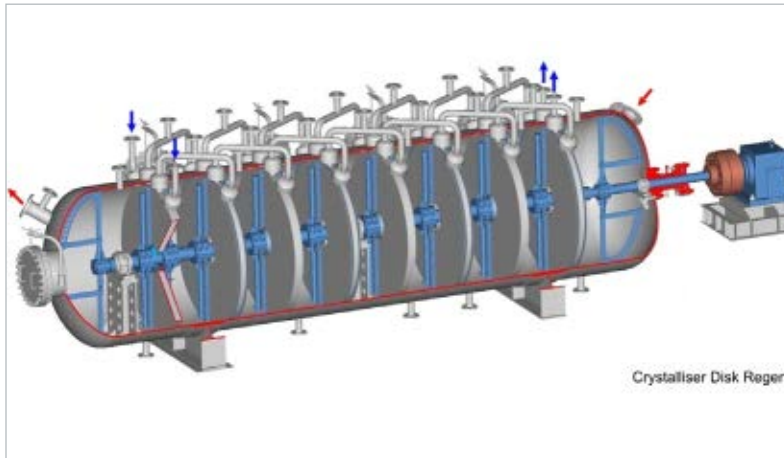

Stantec Consulting Ltd. Hardisty Contract Tankage Hardisty, Canada

Located in Alberta, Canada, the \$635 million Hardisty Contract Tankage terminal will provide services to accumulate medium- and long-term liquid crude volumes on a fee-for-service basis. Stantec Consulting performed the detailed engineering, including identification and evaluation of cost-saving strategies, for 18 crude oil tanks and one diluent tank with total tankage volume of 7.5 million barrels.

The scope included design and development of associated equipment, facilities and infrastructure. Using STAAD.Pro, AutoPLANT, and ProSteel for civil, mechanical, and structural design enabled the firm to optimize the site layout, system hydraulics, tank density, and cut-and-fill balance on a site that undulates at various gradients from 2 to 10 percent. The 3D modeling featured compact designs and interference avoidance and reduced hours spent sizing equipment.

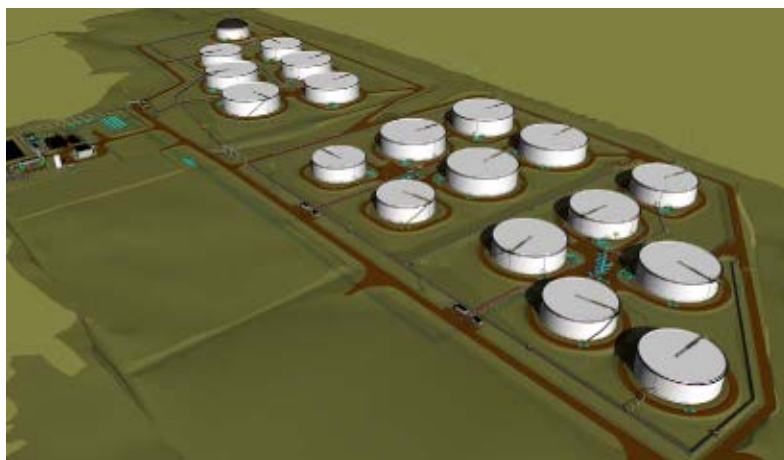

POWER GENERATION

Advanced technology aids in the delivery of high-performance buildings not only in terms of aesthetics, but also in areas of safety, energy savings, reduction of CO2 emissions, and compliance with regulations/accreditations. Today's building techniques also must demonstrate a clear return on investment. The projects in this category demonstrate excellence in planning, designing, building, modeling, analyzing, operating, and maintaining one or more buildings.

Bharat Heavy Electricals Limited

Integrated Approach for Structural Analysis and Design for Reinforced Concrete Chimneys

Madhya Pradesh and West Bengal, India

This project in Madhya Pradesh and West Bengal, India, focused on integrating various mathematical modeling stages, load estimation per code, analysis, stress checks, and building a design chain by implementing various intelligent designs and detailing software to create a sustainable chimney. The concrete chimneys will significantly reduce pollution and carbon levels.

By adopting 3D analysis techniques of STAAD.Pro, the design team reduced engineering time and eliminated duplication of efforts at various stages of analysis, design, detailing, reviewing, and document approval. The major benefits achieved by the project team on this \$8 million project were single point data entry, simple visualization through front-end interface, 2D concrete drawing extraction, quick internal platform design modeling, and the ability to easily extract detailed fabrication drawings.



POWER GENERATION

Bharat Heavy Electricals Limited

Interoperable Approach for Structural Engineering From Conceptual Design to Fabrication

Madhya Pradesh and West Bengal, India

Engineers at India-based Bharat Heavy Electricals Limited had a vision for creating an interoperable approach to structural engineering from conceptual design to fabrication. Their goal was to eliminate the hierarchical structure of serial information flow and incorporate a 3D model-based conceptualization and design.

This vision included integrating various stages to build a design chain by utilizing intelligent 3D modeling technology and various other design and detailing tools. The result of this integrated approach creates a single-point data entry, eliminates errors and redesign, and reduces costs. Bharat was able to achieve its goal by deploying STAAD.Pro.

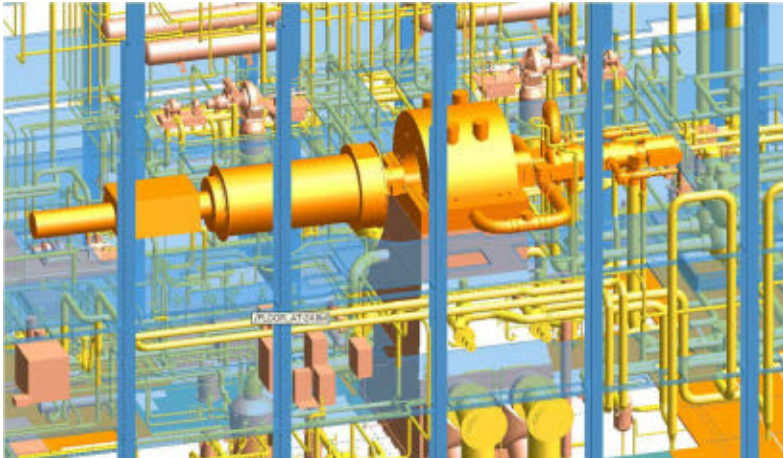

Energotechnika Projekt Sp.z o.o.

EC Zeran Modernization

Warszawa, Poland

Energotechnika Projekt's primary objective is to develop and execute capital projects on schedule, within budget, and with operational excellence. For the \$55 million EC Zeran Modernization project in Warszawa, Poland, the firm replaced an aging turbine with modern equipment that optimized the fluidized boiler, enabling greater efficiency in thermal-to-electric energy conversion.

The challenge was to install the modern turbine in the existing facilities and coordinate installation between branches within a short time. The design team used Bentley Structural, AutoPIPE, and AutoPLANT to shorten design time and reduce the number of people involved in the project.

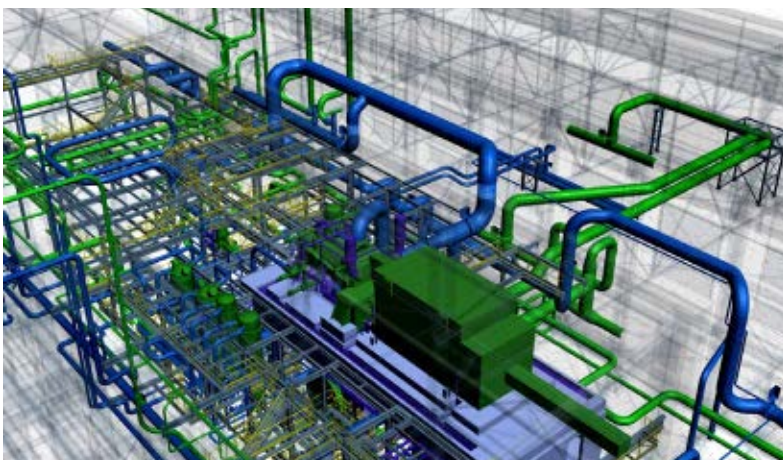

POWER GENERATION

Energotechnika Projekt Sp.z o.o.

IP Kwidzyn Power Plant Expansion

Kwidzyn, Poland

Energotechnika Projekt is one of the largest engineering, procurement, construction, and project management companies in Poland. The goal of the IP Kwidzyn Power Plant Expansion project was to improve plant efficiency and production capacity while decreasing environmental emissions.

The primary goal was to quickly connect the expansion to existing facilities and coordinate installation between branches. The design team used Bentley Structural, AutoPIPE, and AutoPLANT to overcome challenges involved in this \$26 million project to achieve cost savings.

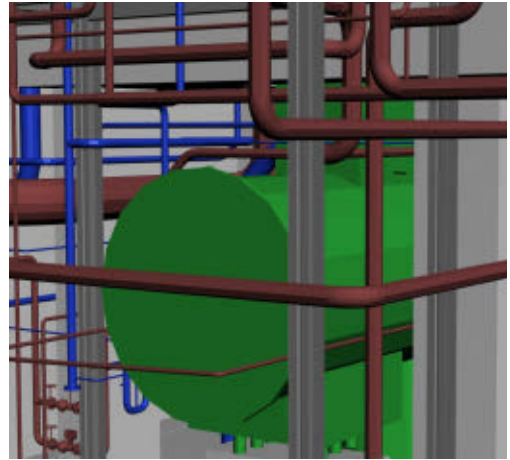
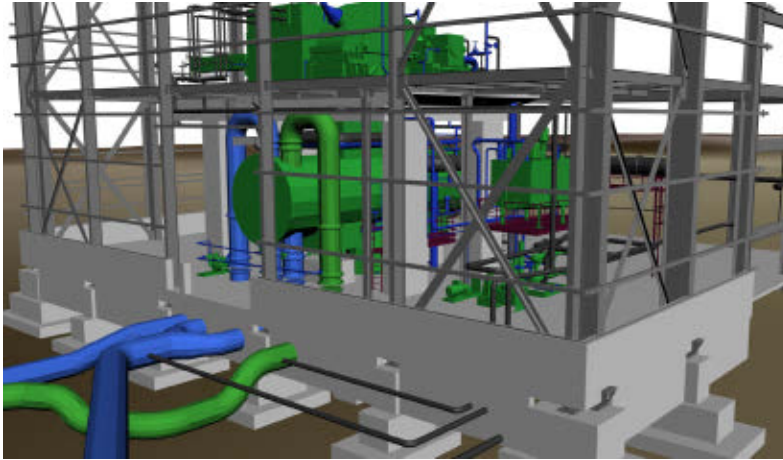

ESI Inc. of Tennessee

Evergreen Community Power

Reading, Pennsylvania, United States

ESI was commissioned to engineer and design a renewable-energy circulating fluidized bed boiler with a 33-megawatt turbine to replace an existing fossil fuel-fired boiler for Phoenix Technology Holdings. The facility will convert biomass-derived material into electricity for a Reading, Pa.-based host paper mill. ESI designed the system with leading-edge air pollution control equipment to ensure that all emissions are as low as possible for a facility of this size.

The fast-track schedule with extensive engineering deliverables could not be met with traditional 2D design. To meet the challenge, ESI hired experienced designers and 3D modeling specialists to complete its largest project to date using AutoPIPE and STAAD.Pro. The designers used hand sketches or 2D drawings to complete sections of the design while 3D specialists created the detailed model.

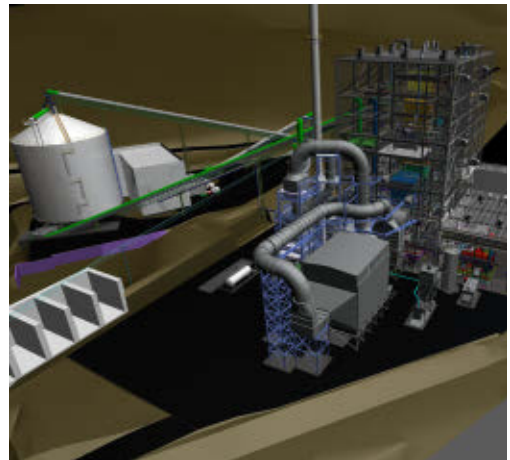
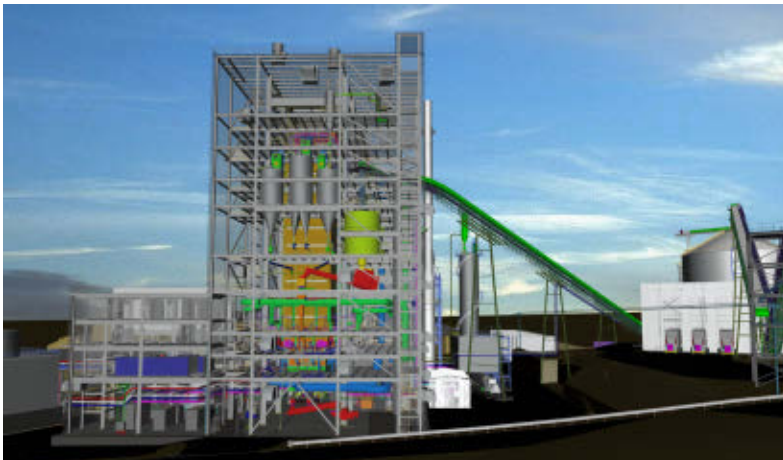

POWER GENERATION

Sargent & Lundy, LLC

Coffeen Wet FGD Unit 1 and 2

Coffeen, Illinois, United States

At more than 40 years old, the two-unit, 1,000-megawatt Coffeen power station in Coffeen, Ill., has gone through various retrofits and modifications to improve its efficiency. To meet the latest federal clean air legislation, it required \$500 million in modifications to burn high-sulfur coal while meeting emissions standards. Sargent & Lundy developed an optimized design for installing SO₂ scrubbers on both units and a new electrostatic precipitator on Unit 2.

MicroStation, Bentley Structural, Bentley Navigator, TriForma, and STAAD.Pro managed the 3D model and integrated more than 900 models from equipment suppliers. This facilitated accurate and up-to-date internal and external design reviews, interference checking, and design communications. The products also helped construction sequencing to minimize plant outage time and construction costs.

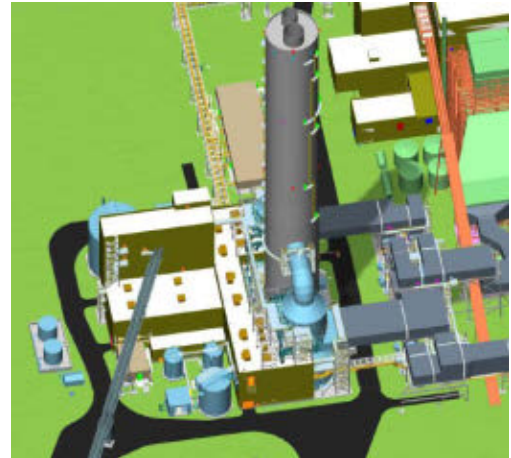
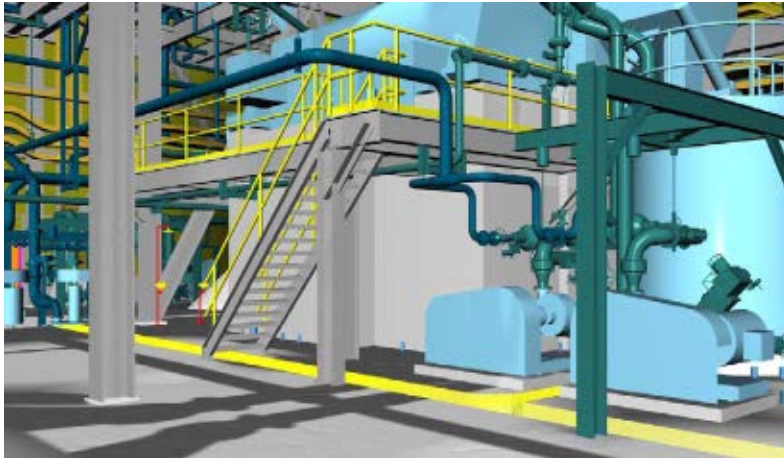

2009 FINALIST

Sargent & Lundy, LLC

J. Lamar Stall Unit at Arsenal Hill

Shreveport, Louisiana, United States

To meet additional electricity demand through 2010 and beyond, the J. Lamar Stall Unit at Arsenal Hill—a 508-megawatt, combined-cycle natural gas-fired plant—is being designed and constructed at American Electric Power's and Southwestern Electric Power Company's existing Arsenal Hill Power Plant site in Shreveport, La. The goal is to add a new power plant that will be a highly reliable, environmentally sound, and an economical resource of electric power to support the region's growing energy demands.

The station is being installed on an existing site within city limits at the site of several older operating units. A primary challenge was fitting all of the plant components into an existing site with unusual boundaries and minimal space. Sargent & Lundy deployed MicroStation, Bentley HVAC, Bentley Navigator, and STAAD.Pro, which enabled model reviews and interference checking prior to construction releases to minimize field changes and stay on schedule.



POWER GENERATION

Sargent & Lundy, LLC

Riverside Repowering Project

Minneapolis, Minnesota, United States

The Riverside Power Plant has been a critical source of electricity for downtown Minneapolis, Minn., and surrounding communities since 1911. Converting the existing coal-fired station into a natural gas-fired plant will allow cleaner and more efficient operations as well as significantly reduce air emissions. Generating capacity will increase by approximately 73 megawatts.

With Sargent & Lundy's proprietary 3D model platform built around Bentley products coupled with several other systems, the project connected team members to develop an optimized design and provide almost around-the-clock work. MicroStation, Bentley HVAC, Bentley Navigator, and STAAD.Pro helped save time and money during construction sequencing, interference checking, walk-throughs, and constructability reviews.

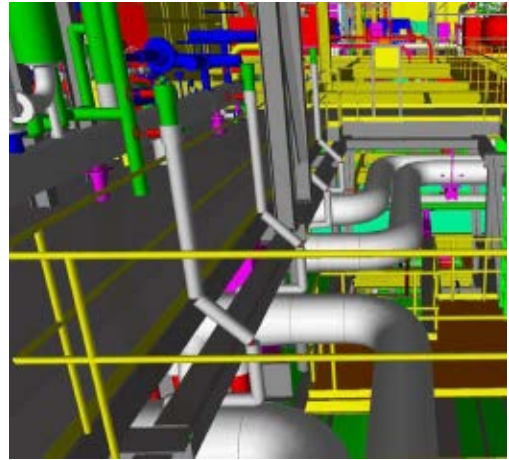
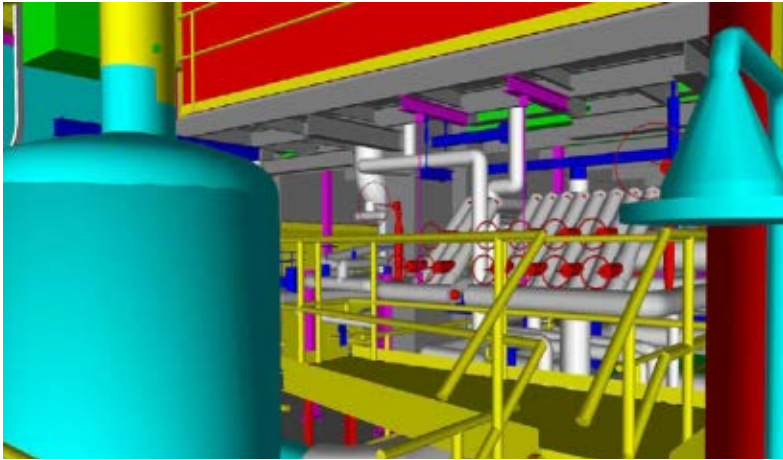

Southern Company

Environmental Project—Scrubbers

Alabama, Georgia, Florida, and Mississippi, United States

In an effort to promote cleaner air in Alabama, Georgia, Florida, and Mississippi, the Southern Company installed scrubbers to remove sulfur dioxide from the flue gas at several coal-fired generating units in the company's system. The scrubbers remove sulfur dioxide and reduce emissions to negligible amounts through a chemical reaction that generates gypsum as a by-product.

The project team implemented an integrated design approach to install the scrubbers and keep the focus on safety, reliability, and cost. This helped overcome the challenges of working around plant outages and managing resources of the simultaneous projects. Through the cooperative team effort and use of STAAD.Pro, Bentley Structural, and AutoPLANT, the project team reduced rework that resulted from interferences and increased overall design efficiency.

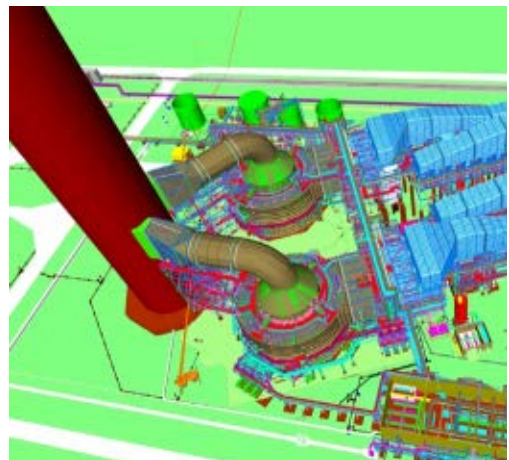
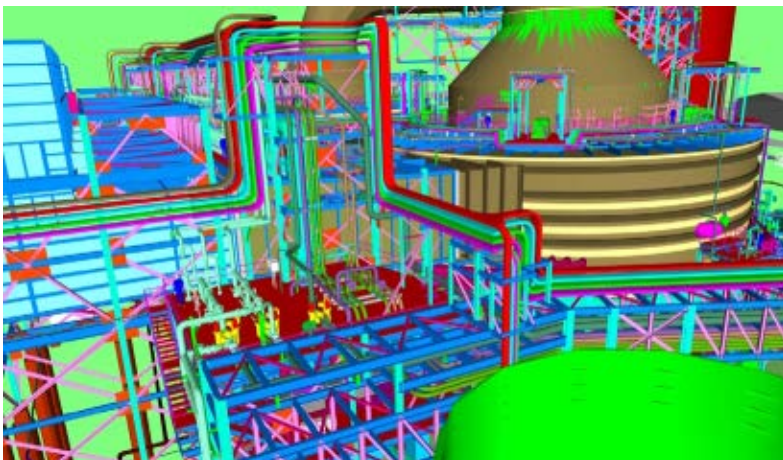

STRUCTURAL ENGINEERING

Projects in this category demonstrate excellence in planning, modeling, analyzing, designing, documenting, detailing, or delivering one or more structures. They also illustrate how the use of technical innovation can deliver high-quality structures or improved structural project workflows. Quality of these structures may be manifested in terms of the structure's functional performance, delivery process, or quality of service or otherwise.

Arup

The Elements—Livingston

Livingston, Scotland

The Elements is a £90 million extension to the Almondvale Shopping Center in Livingston, Scotland, consisting of six new buildings linked by a high-quality mall covered by a lightweight EFTE free form fabric roof. The biggest challenge was to produce a large amount of accurate production information on a very tight timescale so on-site work and steelwork fabrication could commence.

Arup used Bentley Structural mainly for its ability to link with Bentley's RAM Structural System, which allowed Arup to go straight from analysis models to 3D Bentley Structural models. As the majority of the buildings had already been modeled by Arup's London office, the design team converted these structural models into Bentley Structural models using the SNDF import option.

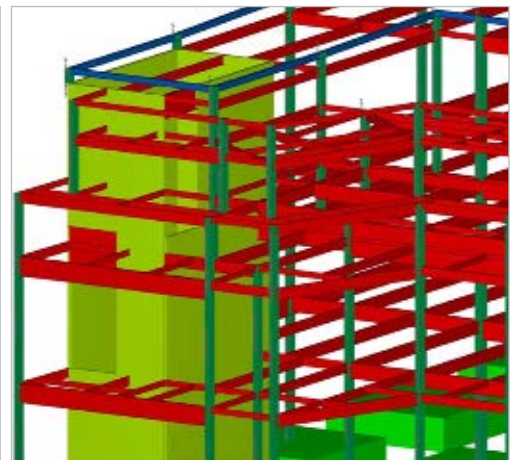
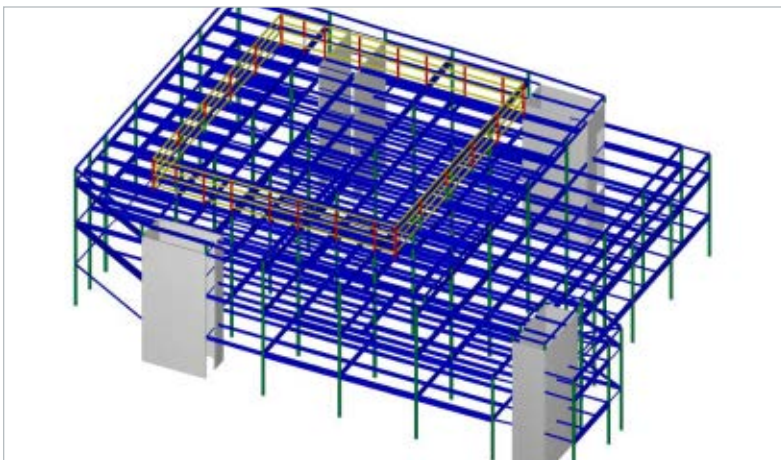

2007 FINALIST

STRUCTURAL ENGINEERING

Baldrige & Associates Structural Engineering, Inc.

Trump International Hotel & Tower at Waikiki Beach Walk

Waikiki, Hawaii, United States

The primary goal of this project was to provide the finest accommodations and best Pacific Ocean and Diamond Head views in Waikiki, Hawaii. Baldrige & Associates created an innovative structure that fulfills its purpose without interfering with views or saleable space. An innovative thin-floor system allows for additional floors in the \$442 million hotel and tower.

Constrained by Waikiki's 350-foot height limit, the project team used RAM Concept to design 19 unique floor slabs. Lower floors were designed with 6-inch slabs and upper floors with longer spans used 6.5-inch slabs. With an integrated design process for post-tensioned concrete slabs, including 3D finite-element analysis and drawing-ready rebar detailing, RAM Concept allowed quick exploration of various slab alternatives, leading to an optimized design.

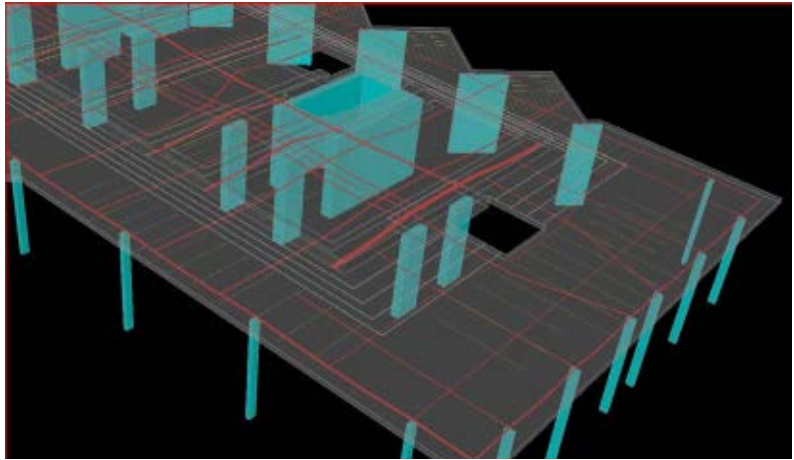

CH2M HILL

HOLCIM Cement Plant

Bloomsdale, Missouri, United States

One of the world's largest cement plants is being designed by CH2M HILL. The plant is situated on 3,900 acres along the Mississippi River in Ste. Genevieve County, Missouri. The facility will be built and operated on 1,700 acres, including the quarry and harbor areas. Approximately 2,200 acres are being preserved as conservation easement.

ProjectWise enabled CH2M Hill to have people in eight different offices work on the same project and in doing so saved the firm hours of time and money. By using ProjectWise, the engineers and designers were able to determine who was working on a particular file at the moment and use the built-in messenger service to contact that individual instantly. In addition, Bentley's STAAD solution enabled the firm to quickly turn information from the General Arrangement drawings into the structural calculation model.

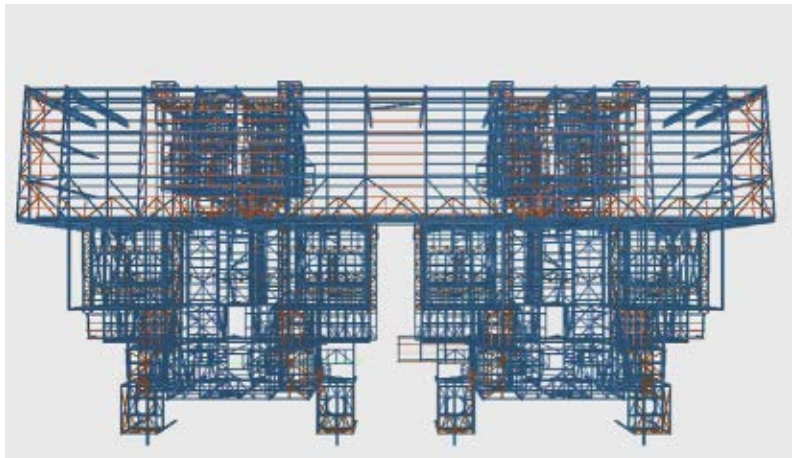
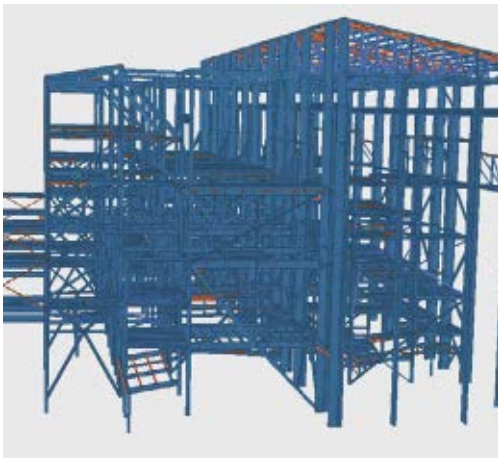

2007 FINALIST

DHV BV

Terminal Breda

Breda, Netherlands

Breda Central Station in the Netherlands will be one of the five stations of the Dutch part of the high-speed railway link between Amsterdam and Paris. ProRail and the municipality of Breda will reconstruct the entire railway station and surrounding city blocks. This will result in a total new terminal complex consisting a new (third) platform, new bus station, bicycle parking, a new and widened passenger tunnel, integrated office building, shops, four restaurants, apartments, and an elevated car park for 700 cars.

Due to the large scale of the project, the model was split up in building blocks drafted in 3D. The advantage of this approach—which used MicroStation and Bentley's BIM offerings—was the simplification of a complex project and an increase in design freedom. Unlike flat drawings, a 3D model provides an immediate understanding of the design and the structural possibilities, speeding the flow of communications.

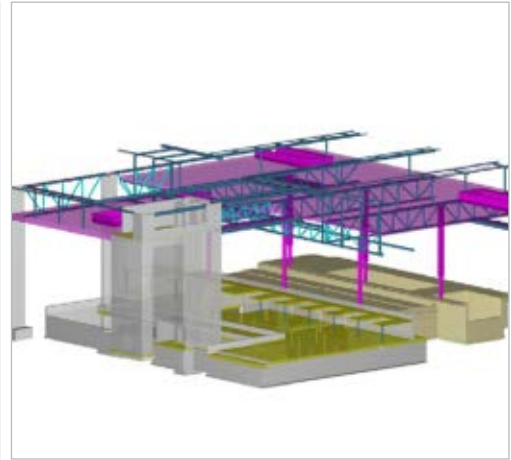
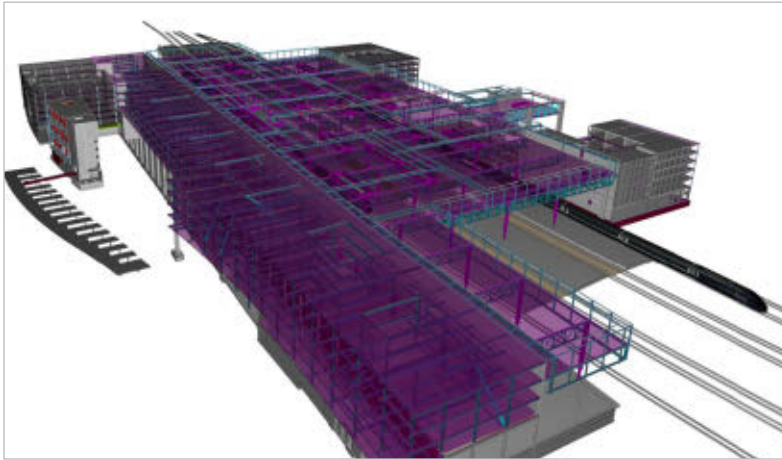

Edge Structures Ltd

Wimbledon Centre Court Redevelopment and Retractable Roof

Wimbledon, United Kingdom

The four-year improvement program at the All-England Club in a London suburb of the United Kingdom was staged around the annual Wimbledon championships, a feat that required collaboration among the design team, main contractor, and supplier fabricators. The project scope included redeveloping the east stand of center court, extending the terrace to provide an additional six rows of seating, and adding a retractable roof for adverse weather conditions.

The obstacles raised by this piecemeal approach to building were resolved by modeling and testing. During the development stages of the design, Bentley software integrated the work of multiple professionals and displayed work-in-progress in 3D. This saved time normally lost in digital exchange and commenting. It also allowed Edge Structures to complete the design with fewer resources.

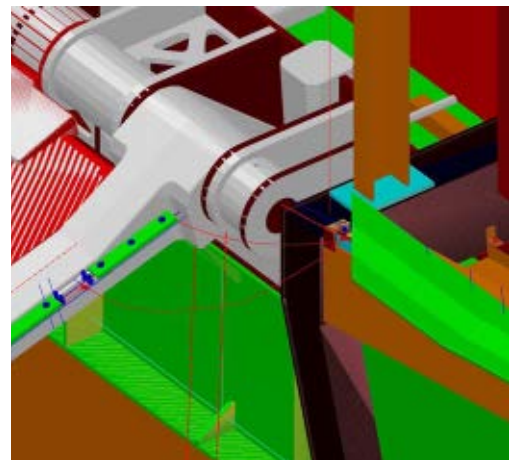

2009 WINNER

STRUCTURAL ENGINEERING

Fine Engineering

The Aspen Lofts

Boise, Idaho, United States

Developer Scott Kimball envisioned an urban residential project in downtown Boise, Idaho, within walking distance of shops, restaurants, parks, entertainment, and work opportunities. However, the site was only 33-by-180 feet, bounded on three sides by an existing parking structure. Creativity and thoughtful design allowed Kimball to develop a \$25 million, mixed-use, 17-story, 132,000-square-foot high-rise.

The Aspen Lofts includes 75 residential condominiums, retail and office space, and private parking. Fine Engineering used RAM Concept to design the 54-inch-thick mat foundation, 17 floors of 8-inch post-tensioned concrete, and the 18-inch concrete shear walls. Slab design models were used to determine lateral load distributions and reduce shear wall thickness to 18 inches. Using minimum-sized structural elements reduced construction materials and costs without impacting structural integrity.



GHG Gebruder Haschel GbR

Big Tropical House

Berlin, Germany

Built in 1907, the Big Tropical House in Berlin is a sort of Noah's Ark for more than 1,358 endangered plant species. It plays an important role in science and research for the Freie Universität Berlin. The 1,750-square-meter glass building has a three-joint-arc steel-bearing structure on the outside, with the glass facade mounted from the inside. Advanced corrosion necessitated restoration of the steel structure.

GHG modeled the steel structure to produce single-part and group drawings, assembly overviews, and parts lists as well as designed the steel substructure and build-on aluminum construction that included sealing, connecting parts, and glass panels. GHG deployed ProSteel for the project that involved more than 60,000 steel and aluminum shapes. The 3D modeling technology helped GHG deliver the design quickly and efficiently.

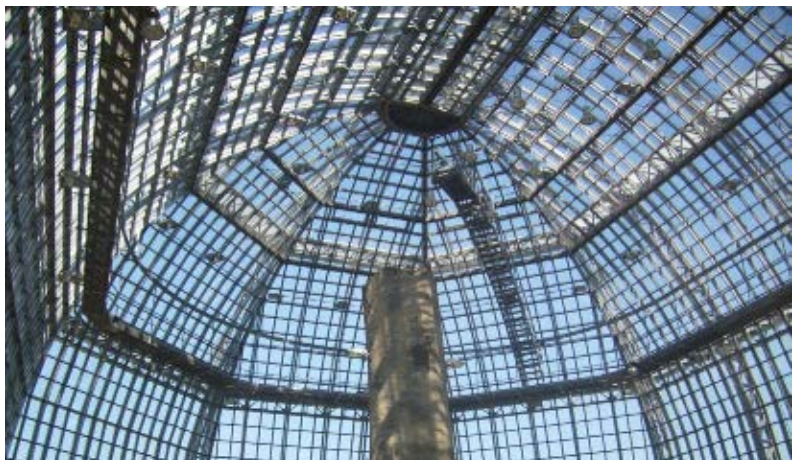

STRUCTURAL ENGINEERING

Hartford Installations Inc.

Historic Spire Retrofit

Ontario, Canada

When an historic timber spire in Canada needed to be reinforced to meet modern loading criteria, a new structural steel frame was designed and constructed for installation inside the original spire at which it would bear on existing masonry walls. Challenges included seismic retrofitting while retaining original timber architecture and fitting the frame inside a tall, narrow structure without interfering with existing wood louvers.

A STAAD.Pro model of the steel frame geometry was created and current building code-required loads were applied to the model. New structural steel members were designed for strength and deflection requirements. STAAD.Pro optimized the steel weight, keeping the sections light enough to be erected 120 feet above ground in the narrow space. Considerable time was saved in analyzing different combinations of complex loadings on the spire structure.

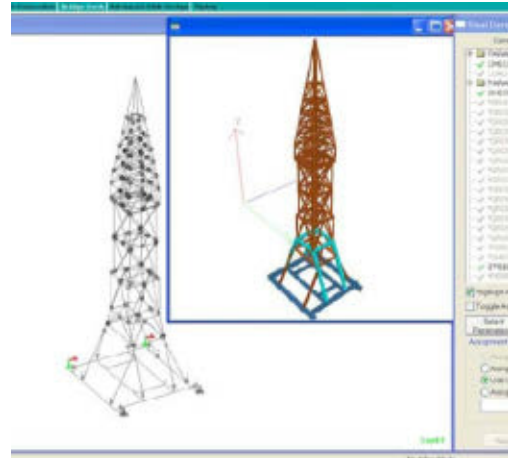

ISC Consulting Engineers A/S

Ship Loader at Statoil Mongstad Oil Terminal

Mongstad, Norway

Located on the North Sea, the new plant for dust-free loading of coke at the Statoil Oil Terminal in Mongstad, Norway, includes a 125-meter inclined conveyor, a 75-meter moveable ship loader, and a pivot tower. Coke is transported from an existing onshore scale house to the pier where it is loaded onto ships. The ship loader is designed to fit different ship sizes, with a boom that extends by 23 meters.

The challenge was to design a flexible system that provides a high degree of environmental protection. A slewing ring made of laminated composite material designed for use with a large-diameter roller bearing was the key to developing an efficient, dust-free loader. ProSteel was used to develop the design, workshop drawings including NC files, and installation and maintenance documentation.

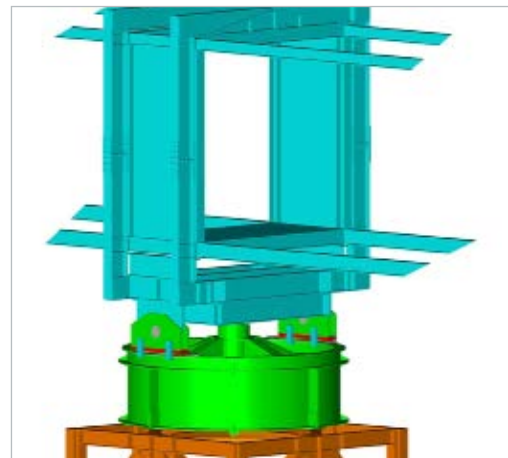
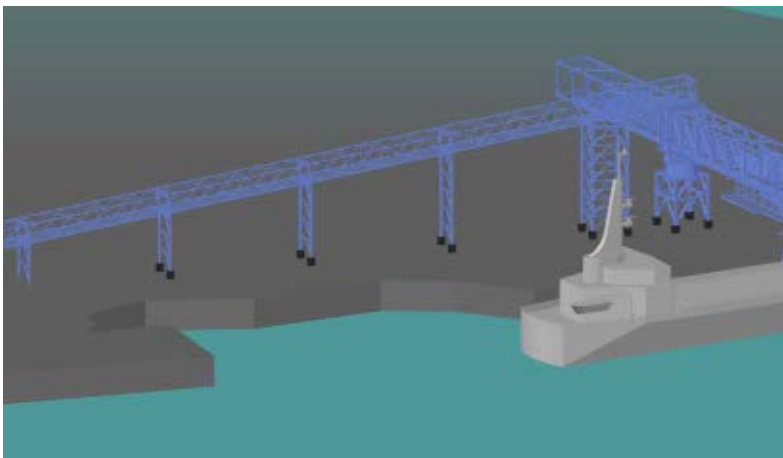

STRUCTURAL ENGINEERING

Jacobs Engineering Group

#3 Crude Unit Revamp

Pine Bend, Minnesota, United States

The #3 Crude Revamp Project was a unit upgrade at the FlintHills Resources Refinery in Pine Bend, Minnesota. The project would increase production from 100,000 to 150,000 barrels per day at an estimated cost of \$170 million. One major element of the project was the addition of a new heater. From a structural design perspective, the location of the new heater presented challenges.

As with all unit upgrades, physical plot space was very limited, but the most challenging element was what was below ground. The most notable items were two 24-inch diameter cooling water lines four feet below grade, which could not be taken out of service to be relocated. Using Bentley's STAAD products, the firm was able to analyze and design the large, complex foundation with ease, knowing that the results would be accurate.

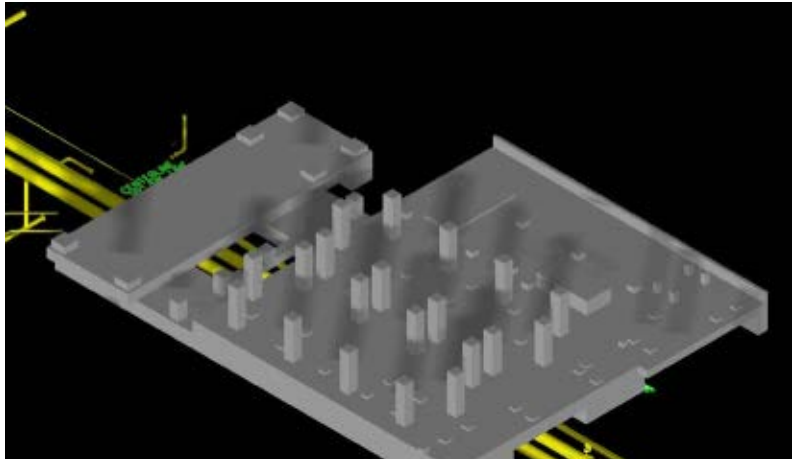
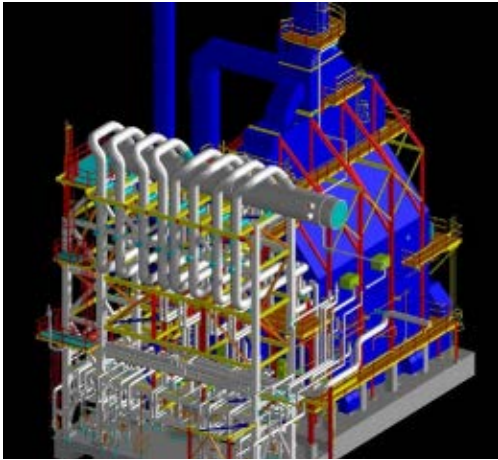

JDI Group, Inc.

Toledo Zoo Elephant Exhibit Renovation Project

Toledo, Ohio, United States

The JDI Group was contracted to engineer the structural elements for a "shade tree" as part of the Toledo Zoo Elephant Exhibit Renovation Project in Ohio. Extending more than 40 feet above grade, the structure is fabricated from structural steel, with the gunite concrete-covered base tapering upward to simulate a tree trunk and tubular steel "branches" covered with netting to simulate leaves. Two hoists suspended from the branches control devices that entertain the elephants.

Because of the angles of the branches, cantilevers, and projections, the structural elements were subjected to flexure, compression, and torsion. The geometry was imported to RAM Advanse (now RAM Elements), in which loads were applied and various loading combinations were created—including loads induced by wind, snow, hoist, and an angry elephant. The software quickly analyzed forces and stresses in the members and allowed designers to optimize the design.



STRUCTURAL ENGINEERING

Jirsa Hedrick & Associates, Inc

Spire

Denver, Colorado, United States

The Spire is a 41-story condominium building located directly across from the Colorado Convention Center in downtown Denver, Colo. The ground floor features retail space and the next seven levels above are parking for residents and visitors. Level nine and 10 have common amenities for residents that include an outdoor pool and sundeck, fitness center, and meeting spaces.

Bentley's RAM solutions were instrumental in providing an integrated approach from feasibility studies to construction documents. Jirsa Hedrick was able to quickly react to structural requirements associated with alternative schemes. The visualizations allowed the designer to quickly review complex models and to correct modeling errors. Savings due to optimization are estimated to be \$2.5 to \$3 million in the slab and lateral systems.



KBR

Existing Petrochem Facility

Toledo, Ohio, United States

Increased production of an existing fluid catalyst cracking unit required a structural evaluation of the 47-year-old reactor structure in Toledo, Ohio, to determine the feasibility of the proposed expansion.

Bentley's STAAD products were used to generate wind load on this complex structure. Modeling was performed using the graphical user interface. Record low execution time for this project earned praises from the client. KBR saved 300 man-hours and \$30,000 as a result of enhanced 3D graphical views and application of wind load.



STRUCTURAL ENGINEERING

KNA Consulting Engineers, Inc
Murrieta Mesa High School
Murrieta, California, United States

Murrieta Mesa High School, a \$120 million high school located on a 62-acre site in Murrieta, California, will have a capacity of approximately 2,300 students. There will be 82 classrooms in the 249,000 square-foot school, which will also include a stadium, pool complex, athletic fields, tennis courts, basketball courts, sand volleyball courts, and handball courts.

The architectural requirements of the project required a broad range of materials and structural systems, and a seismic fault on the site added complexity. The use of Bentley's suite of integrated RAM products allowed KNA to develop design documents that were completely coordinated with the calculations in an extremely aggressive time frame. The time savings were on the order of four to six weeks, and the two days of training and additional RAM more than paid for themselves on this one project.



2007 FINALIST

L. Robert Kimball & Associates
Drexel University: Armory Athletics and Convocation Center
Philadelphia, Pennsylvania, United States

This feasibility study explored solutions to convert an armory that was built in 1916 into a convocation center for Drexel University in Philadelphia, Pa. The building was constructed using a series of tied arch trusses, with the tie occurring in the existing slab on grade. Because the armory is listed on the National Register of Historic Places, only minor alterations were allowed in order to preserve its historic integrity.

RAM Advanse (now RAM Elements) was used to analyze the existing structure and potential solutions for the \$71 million conversion. A truss system lowered the existing floor level approximately 14 feet, because the impact on the existing trusses was minimal. The RAM software allowed the team to quickly evaluate options and quickly select the most efficient choices, giving the owner a cost-effective solution for adaptive reuse of the armory.

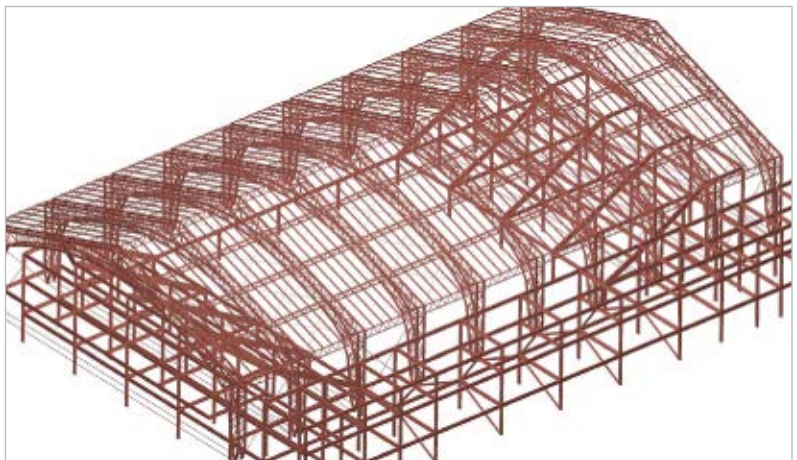
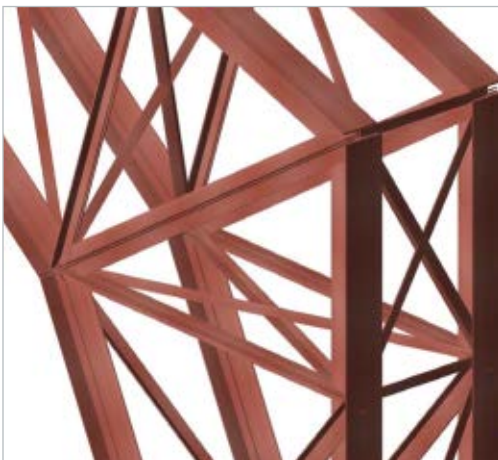

Larsen & Toubro Limited

Rajasthan Northern Area Development Project, Mangla Process Terminal, Cairn Energy India Pty Limited

Rajasthan, India

The northern area development project in Rajasthan, India, includes the Mangla process terminal, oil well pad development, Thumbali water field, and operation base enlargement. The structural team designed and analyzed pipe racks consisting of process pipe carrying structures with pipe bridges and accessibility platforms on various levels. Due to the tight, fast-track schedule, the team used the same 3D model for analysis as well as for drafting purposes.

Analysis and design of the pipe rack structure was done using STAAD.Pro, and the 3D model was transferred to ProSteel for structural general arrangement, fabrication drawing preparation, and materials take-off. Simultaneously, structural weight was verified for procurement purposes. Using one 3D model saved nearly 70 percent of time typically spent in structural modeling for drafting purposes.

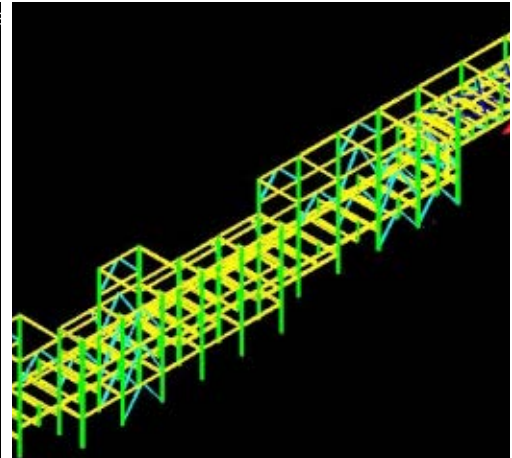
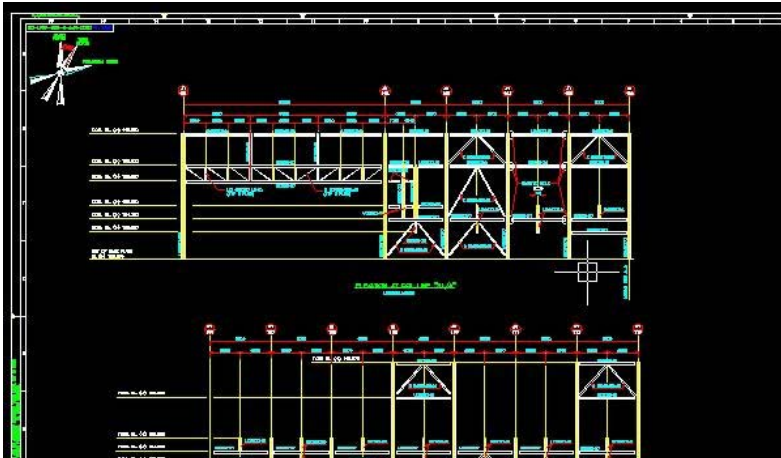

MERO-TSK International GmbH & Co. KG

Orchard Turn

Singapore

Located on the last available site on Orchard Road, the most prestigious shopping mile in Singapore, the Orchard Turn development project includes 125,000 square meters of shops, art gallery, and luxury condominiums with a leisure center. The Orchard Turn building will be erected on a floor space of 21,700 square meters above the Orchard Road subway station.

MERO-TSK designed a freeform structure with an irregular wave-shape canopy spanning the public space in front of the building. The geometry is based on a rhomboid grid, with circumferential facades wrapping around the building in undulating curves and cladding elements arranged in irregular patterns. ProSteel's 3D modeling technology helped the team deliver the complex design quickly and efficiently.



STRUCTURAL ENGINEERING

Mott MacDonald Ltd

Foryd Harbour Footbridge

Rhyl, United Kingdom

The Denbighshire County Council in North Wales, United Kingdom, held a design competition for a new walking and cycle bridge at Foryd Harbour in Rhyl. The bridge not only had to open to allow boats to pass and be iconic in design, but it also had to be practical and sustainable. Mott MacDonald provided the design for Kier Construction's submission, which placed second in the competition.

Limited time was available to develop a landmark bridge concept, prove its structural and mechanical feasibility, and provide a sufficiently detailed tender design for the contractor to cost. The solution was an innovative ring girder bascule bridge, which balanced a counterweight fin, ring ballast, and deck cantilever. STAAD.Pro enabled designers to rapidly analyze a number of configurations and confirm that the bridge was sufficiently strong and stable.



Promet Engineers P/L

Ferrexpo AG—Expansion Projects Phase 2

Komsomolsk, Ukraine

This project in Komsomolsk, Ukraine, produced a preliminary design for a magnetite concentrator that overcame challenges posed by construction on a brownfield site. Collaboration was conducted over multiple sites—Perth, London, Zurich, Kiev, and Komsomolsk—and 3D models produced by STAAD. Pro allowed greater and faster understanding of the plant by the project team and the client than would normally be possible with 2D output.

The initial process of structural layout was based on existing modular concepts and exported to STAAD.Pro, which delivered rapid turnaround of structural designs with a significant reduction in engineering hours. Common data libraries gave consistency between engineering design and drafting and ensured quality of the final product. STAAD.Pro was purchased with Russian and Australian Design Codes to provide design to Ukrainian Design Institutes that were already compliant.

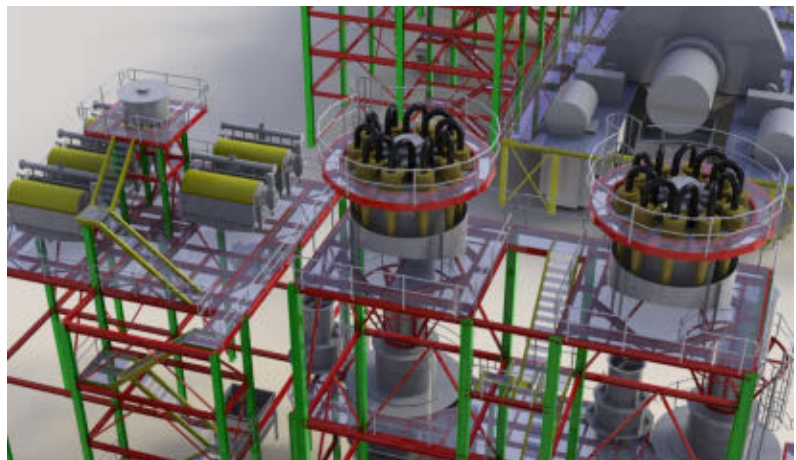

RITES Ltd

Design of New Jubilee Bridge

Kolkata, India

Originally constructed in 1887, the Jubilee Bridge provides an important railway link across the river Hooghly. Although it is still operational, the bridge has severe speed restrictions, so Eastern Railway planned to construct a new one. It commissioned RITES to carry out the detailed studies and recommend a location for the New Jubilee Bridge.

RITES designed a 415.60-meter three-span rail bridge with continuous superstructure used—a first at Indian Railways. The cost of the bridge including substructure is approximately \$30 million. RITES used STAAD.Pro for analysis of the bridge superstructure and MXRIL for alignment. These tools provided an efficient and robust analysis engine whose visualization tools, user-friendly interface, and customized report generation efficiently modeled the superstructure model.

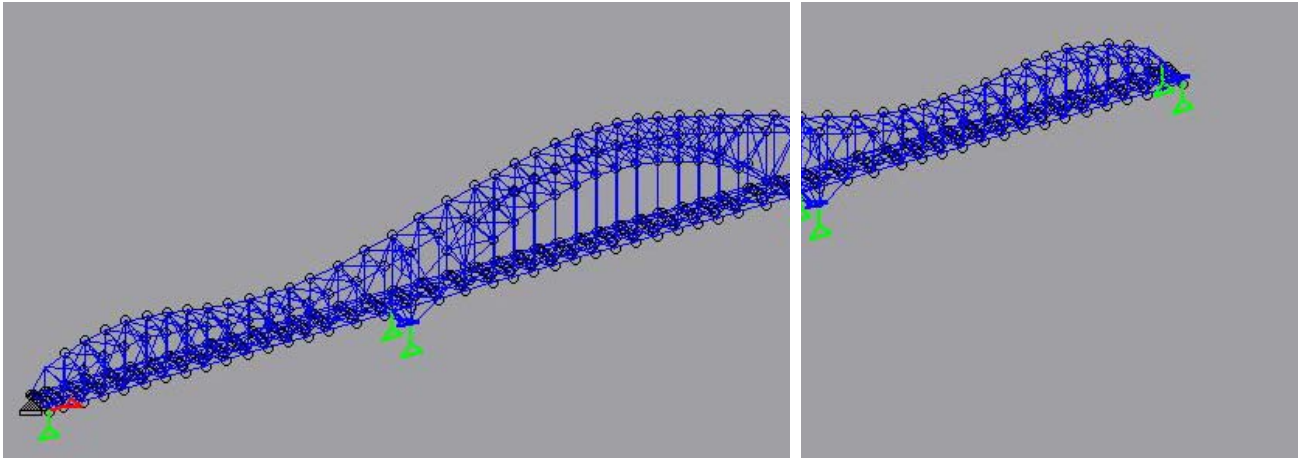

2007 FINALIST

Skidmore, Owings & Merrill LLP

Lotte Super Tower Diagrid Connection Modeling

Seoul, South Korea

The 112-story Lotte Super Tower proposed for Seoul, South Korea, is a 550-meter-tall, mixed-use building with a steel diagrid structural system. The exterior structural diagrid has 68 unique (432 total) joints at which six major members come together at a single point. Morphing from a square base to a circular top, the building geometry posed a technical challenge for the structural engineering team.

The team developed custom tools to manage the diagrid connection geometry, enabling it to create accurate physical and analytical 3D models of the structure. MicroStation and Bentley structural software provided the main interface to the custom application used to parametrically describe and manage the node connections. The 3D model supported creation of 2D and 3D drawings and the provision of accurate digital information to the steel supplier/fabricator.

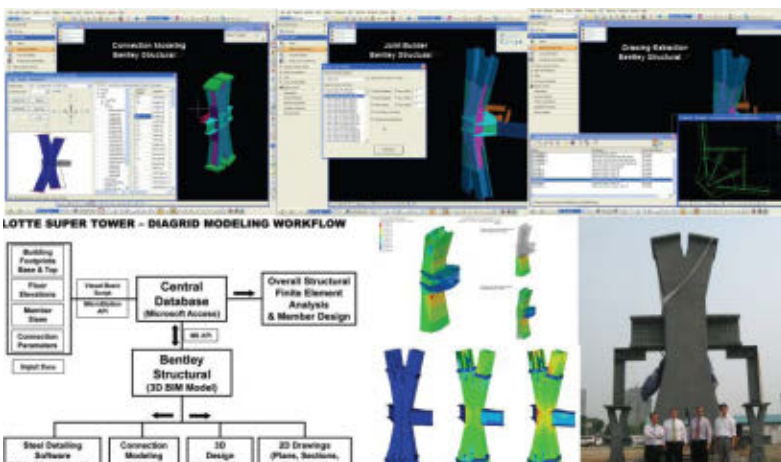

2007 FINALIST

STRUCTURAL ENGINEERING

Southern Company

Flue Gas Ductwork Modularization

Wilsonville, Alabama, United States

The flue gas ductwork modularization project is part of a multibillion dollar environmental program at Southern Company designed to reduce emissions of SO₂ from coal-fired power plants. This project reduced the number of field man-hours required to assemble flue gas ductwork for scrubber projects by developing a modular system that replaces welds with bolts.

Collaboration with the fabricators and erectors allowed all parties to review the 3D models built with Bentley Structural and STAAD.Pro. The visualization capabilities increased the overall understanding of project scope. The use of C-section ductwork modules has reduced field assembly man-hours by 40 percent and reduced man-hours spent assembling ductwork at high elevations by 70 percent.

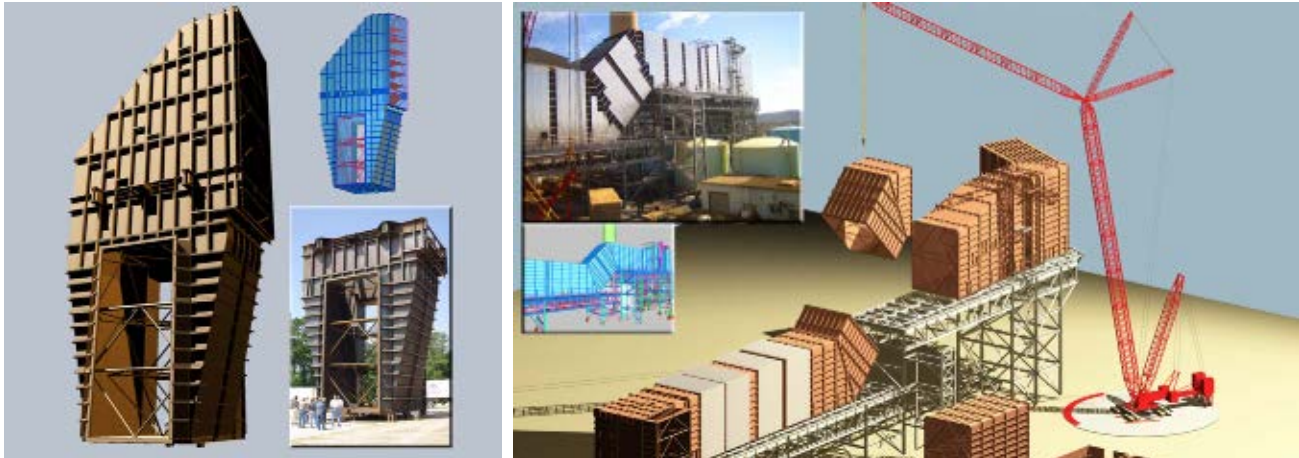

Tata Power Company Limited

Structural Steel Shed for Ash Water Cum Compressor House

Mumbai, India

As part of a thermal power project in Mumbai, India, the structural steel shed for an ash water cum compressor house was designed using STAAD.Pro. The original design of the ash water cum compressor house was an RCC building, but to save time on the project it was designed as a steel shed.

As this was part of thermal power project, it will help to commission the power plant on time.

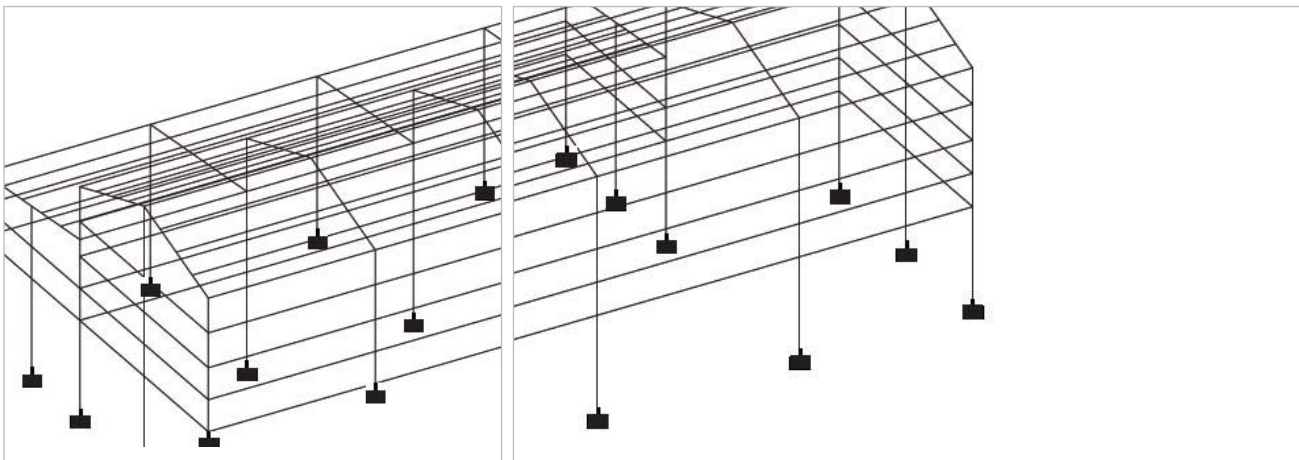

STRUCTURAL ENGINEERING

USACE Portland District

Cougar Dam and Reservoir Adult Fish Collection Facility

Blue River, Oregon, United States

Located on the South Fork of the McKenzie River near Blue River, Ore., the Cougar Adult Fish Collection Facility will assist in a collecting, sorting, and transporting program to connect fish populations located upstream and downstream of Cougar Dam. The \$14.7 million facility includes a fish ladder, pre-sort pool, sorting facility, and two pump structures for water supply.

MicroStation, ProjectWise, and STAAD enabled a shared model approach that allowed for structural, mechanical, electrical, hydraulic, civil, and geotechnical engineers to effectively integrate the design. Challenges were addressed by fostering collaboration among the design team members to maximize product reviews and ensure effective communication.



2009 FINALIST

WSP Group plc

Manchester Hilton

Manchester, United Kingdom

The Manchester Hilton is currently the tallest post tension concrete residential building in the United Kingdom. It is a 49-story structure with 279 rooms for the hotel from levels four to 22, and 219 apartments from levels 25 to the roof. The tower is 155 meters high to the roof parapet and the feature blade structure extends a further 15 meters above the main roof, making the overall structure approximately 170 meters high.

Post-tension concrete was selected for the slab design in order to minimize floor-to-floor height. The accurate modeling provided a challenge to the design team. The ability of RAM and STAAD products to modify input data easily and produce adequate and sensible output permitted the team to make informed decisions during various stages of the project. This was critical for late changes requiring rapid decisions.



2007 WINNER

WATER RESOURCES

Common goals of water resource professionals include increasing efficiencies in engineering processes while minimizing environmental consequences, preserving public capital investment, and enhancing the level of service of costly but necessary water infrastructure. This category features projects that demonstrate the innovative use of technology to construct water treatment plants and to plan, design, manage, and model potable water, wastewater, and stormwater networks.

Carollo Engineers

City of Phoenix 24th Street Water Treatment Plant

Phoenix, Arizona, United States

To control the formation of disinfection by-products in a potable water distribution system, the city of Phoenix, Ariz., implemented an innovative 3D design for a \$65 million, 120 mgd granular activated carbon post-filter contactor facility. Efficient interaction between the city and contractor using 3D models visualized the intricate design, accommodated plant operator needs, and minimized and resolved conflicts between various elements within the contactor pipe gallery.

Weekly team meetings—using ProjectWise to share files and submit drawings—facilitated coordination among the prime consultant and two major subconsultants. The enhanced design process using MicroStation, PlantSpace, and STAAD.Pro allowed the city to improve water quality for customers within budget while making the project up to 25 percent more profitable for the contractor.

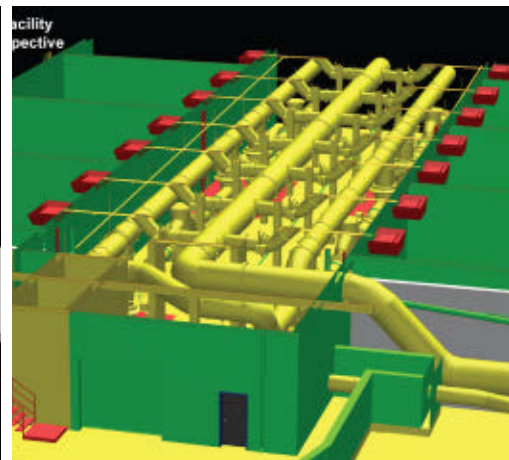
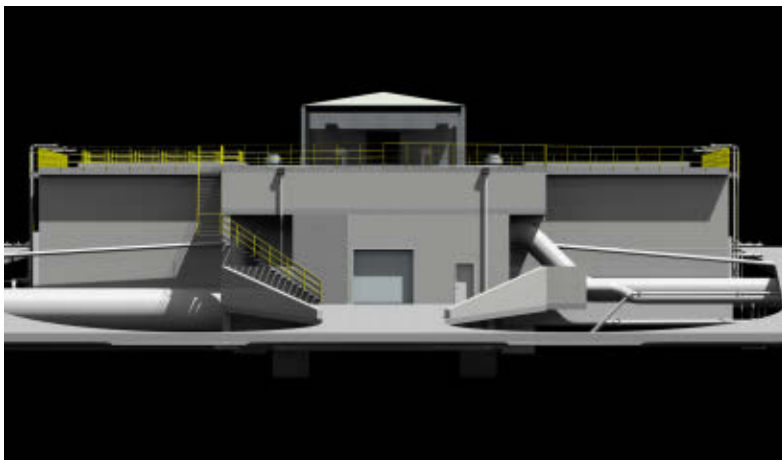

The Walsh Group/Archer Western Contractors Alvarado Water Treatment Plant Expansion San Diego, California, United States

The Alvarado Water Treatment Plant is one of three facilities that supplies San Diego, Calif., with drinking water. In Phase IV of the expansion project, Archer Western Contractors is installing a new ozone system that will increase the output from 120 to 200 million gallons per day. The \$65 million project includes designing a 14,000-cubic-yard concrete structure, purchasing and installing the ozone system, and all ancillary equipment and site work.

Archer used MicroStation, PlantSpace, AutoPIPE, and ProjectWise Navigator to convert the designers' 2D documents into 3D models to coordinate all systems, verify the design, and collaborate with subcontractors and vendors. An accurate model with structural, mechanical, electrical, piping, and equipment details helped prevent conflicts, enhance constructability, and forecast equipment issues.

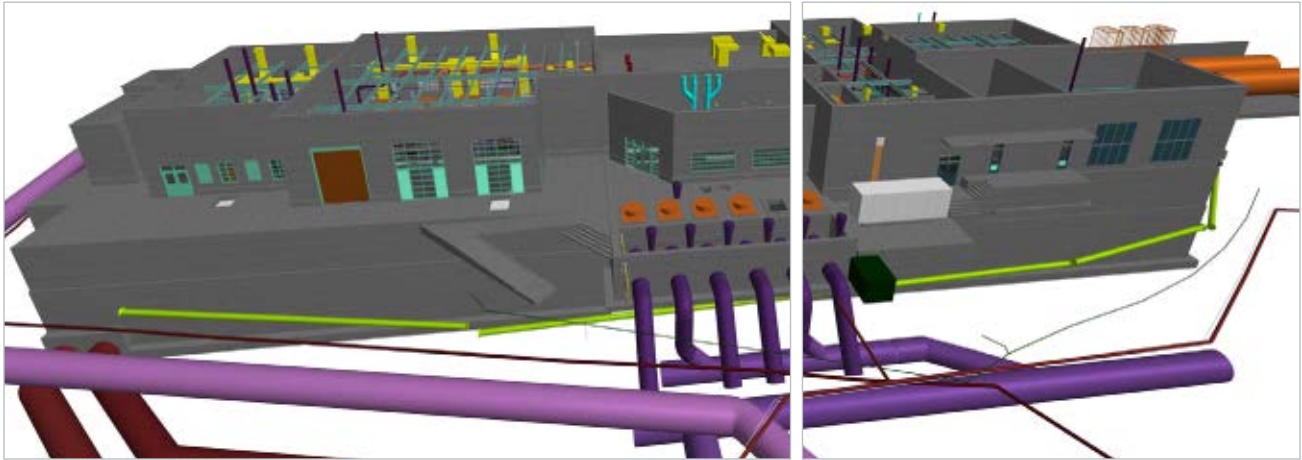

INDEX – ALPHABETICAL BY ORGANIZATION

| | ORGANIZATION NAME | PROJECT NAME | PAGE |
|---|--|--|------|
| | Alstom Projects India Limited | Tan Jun Bin | 10 |
| F | Arup | The Elements—Livingston | 25 |
| | Baldrige & Associates Structural Engineering, Inc. | Trump International Hotel & Tower at Waikiki Beach Walk | 26 |
| F | Barge Waggoner Sumner & Cannon, Inc. | AFRC and Army Reserve Program Regional Support Command Headquarters | 8 |
| | Bateman Engineering Pty Ltd | Karara Iron Ore Project | 12 |
| F | BDP | Teddington School | 3 |
| | Bharat Heavy Electricals Limited | Integrated Approach for Structural Analysis and Design for Reinforced Concrete Chimneys | 20 |
| | Bharat Heavy Electricals Limited | Interoperable Approach for Structural Engineering From Conceptual Design to Fabrication | 21 |
| | Carollo Engineers | City of Phoenix 24th Street Water Treatment Plant | 38 |
| F | CH2M HILL | HOLCIM Cement Plant | 26 |
| | DHV BV | Blaak 31 Residence Rotterdam City | 3 |
| | DHV BV | Terminal Breda | 27 |
| | Dr.techn.Olav Olsen a.s. | MPU Heavy Lifter | 15 |
| W | Edge Structures Ltd | Wimbledon Centre Court Redevelopment and Retractable Roof | 27 |
| | Energotechnika Projekt Sp.z o.o. | EC Zeran Modernization | 21 |
| | Energotechnika Projekt Sp.z o.o. | IP Kwidzyn Power Plant Expansion | 22 |
| | ESI Inc. of Tennessee | Evergreen Community Power | 22 |
| | Fine Engineering | The Aspen Lofts | 28 |
| | Fitzpatrick Engineering Group PLLC | Northeast Medical Center Acute Care Facility Expansion | 4 |
| F | Flad Architects | Biotechnology Company—Fill/Finish Facility | 4 |
| F | GHAFAARI Associates, LLC and General Motors | 3D Enabled—Plant Expansion at the General Motors Toledo Powertrain Transmission Plant | 10 |
| | GHG Gebruder Haschel GbR | Big Tropical House | 28 |
| | Gresham, Smith and Partners | Nissan Americas Corporate Facility | 5 |
| | Hartford Installations Inc. | Historic Spire Retrofit | 29 |
| | Hatch | Feasibility Study of El Lajjun Oil Shale Project | 15 |
| | ISC Consulting Engineers A/S | Ship Loader at Statoil Mongstad Oil Terminal | 29 |
| | Jacobs Engineering Group | #3 Crude Unit Revamp | 30 |
| | JDI Group, Inc. | Toledo Zoo Elephant Exhibit Renovation Project | 30 |
| | Jirsa Hedrick & Associates, Inc | Spire | 31 |
| | KBR | Existing Petrochem Facility | 31 |
| F | KNA Consulting Engineers, Inc | Murrieta Mesa High School | 32 |
| | Koksoprojekt Spolka z o.o. | Plant for Ammonia Catalytic Degradation and the Clauss-Method Sulfur Production in Unit of the Coke Plant “Przyjazn” | 16 |
| | Koksoprojekt Spolka z o.o. | Plant for Deacidification and Ammonia Desorption | 16 |
| | Korda/Nemeth Engineering Inc | Ithaca College Athletics and Events Center | 5 |
| | L. Robert Kimball & Associates | Drexel University: Armory Athletics and Convocation Center | 32 |
| | Larsen & Toubro Limited | Rajasthan Northern Area Development Project, Mangla Process Terminal, Cairn Energy India Pty Limited | 33 |
| | L-Con Engineers and Constructors | Dynamic Fuels | 17 |
| | MECON Limited | 262 Cubic-Meter Blast Furnace Complex | 12 |
| | Mehro Consultants | NSCBI Integrated Terminal Building, Kolkata Airport | 9 |
| | MERO-TSK International GmbH & Co. KG | Orchard Turn | 33 |
| | Mott MacDonald Ltd | Foryd Harbour Footbridge | 34 |
| | Nafta-Gaz Sp. z o.o. | Natural Gas Deposits Arrangement | 17 |
| | Nafta-Gaz Sp. z o.o. | Natural Gas Well Arrangement | 18 |

| | ORGANIZATION NAME | PROJECT NAME | PAGE |
|---|--|---|------|
| F | NBBJ and Korda/Nemeth | Glickman Tower | 6 |
| | NK Rosneft–NTC | VNK1 | 18 |
| | PARADIGM Structural Engineers, Inc. | Virginia Data Center 6 | 6 |
| F | PDC Consultants | BHPB Rapid-Growth Project Newman Hub | 13 |
| | PDC Consultants | Pilbara Iron Ore and Infrastructure Project–Cloudbreak Ore Handling | 13 |
| | Petrochim Engineering | Crystalliser Disk Regenerativ | 19 |
| | Promet Engineers P/L | Ferrexpo AG–Expansion Projects Phase 2 | 34 |
| | Quotient Engineering Inc. | Utkal Alumina Liquor Evaporation Project | 14 |
| F | RITES Ltd | Design of New Jubilee Bridge | 35 |
| | Saankhya TechNeering Private Limited | Industrial Structures | 11 |
| F | Sargent & Lundy, LLC | Coffeen Wet FGD Unit 1 and 2 | 23 |
| | Sargent & Lundy, LLC | J. Lamar Stall Unit at Arsenal Hill | 23 |
| | Sargent & Lundy, LLC | Riverside Repowering Project | 24 |
| F | Skidmore, Owings & Merrill LLP | Lotte Super Tower Diagrid Connection Modeling | 35 |
| | Southern Company | Environmental Project–Scrubbers | 24 |
| | Southern Company | Flue Gas Ductwork Modularization | 36 |
| | Stantec Consulting Ltd. | Hardisty Contract Tankage | 19 |
| | Structural Affiliates International, Inc. | Torre Planetarium | 7 |
| | Tata Power Company Limited | Structural Steel Shed for Ash Water Cum Compressor House | 36 |
| | The Walsh Group/Archer Western Contractors | Alvarado Water Treatment Plant Expansion | 39 |
| | Tipping Mar | The David Brower Center | 7 |
| F | USACE Portland District | Cougar Dam and Reservoir Adult Fish Collection Facility | 37 |
| W | WSP Group plc | Manchester Hilton | 37 |

Recognizing the critical importance of being a good corporate citizen, Bentley is uncompromisingly committed to supporting ecological sustainability. This support goes beyond the stewardship of environmental resources to include investment in strategic educational and training initiatives that foster a workforce of skilled infrastructure professionals capable of meeting the world’s growing sustainability challenges.

Special editions of *The Year in Infrastructure* series of publications are one small example of Bentley’s commitment to promoting sustainable development through its business practices. As part of this effort, this publication has been printed on Forest Stewardship Council (FSC) certified paper, which identifies products that contain wood fiber from well-managed forests.

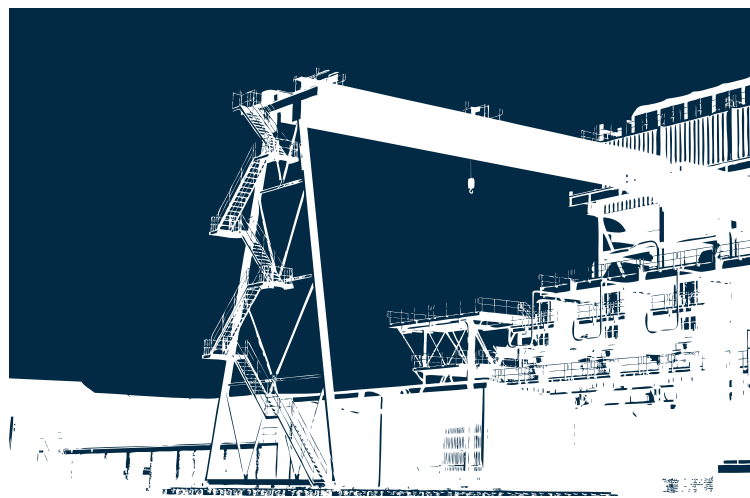
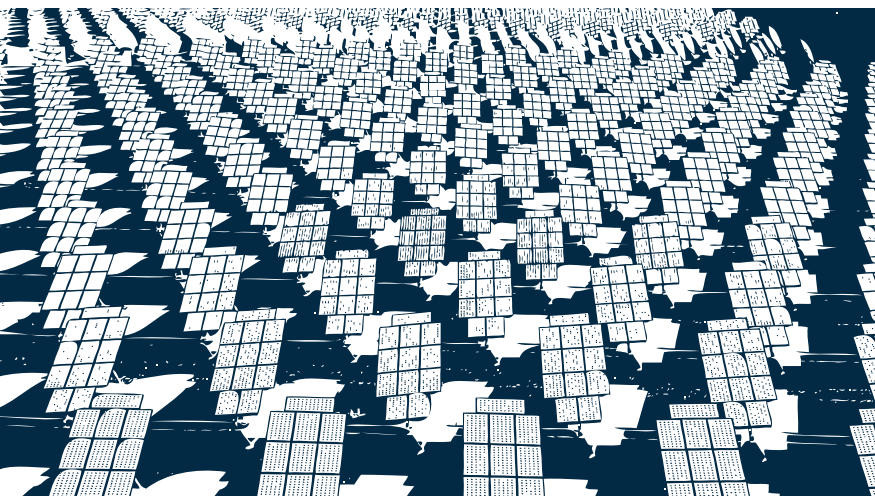
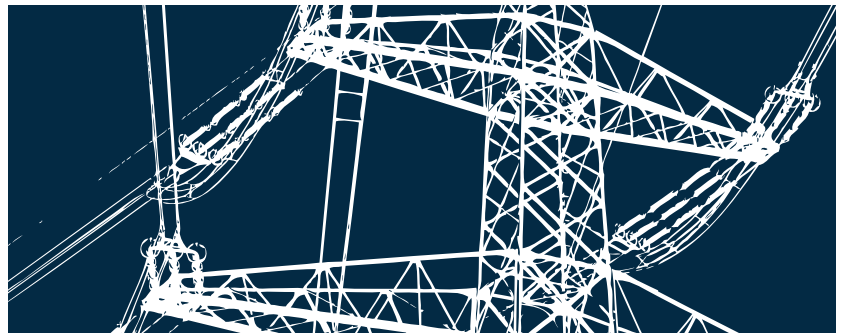

www.bentley.com

