

# Technical data sheet

## Clamp clip 2056, F foot, single, plastic pressure trough, FT

Item number: 1188201



Clamp clip with F-foot, plastic pressure trough made of polypropylene. For vertical and horizontal mounting of 3 single cables on flat bars. With 1-start screw thread on pressure trough, universal hexagonal screw head WAF10, with slot and cross recess. Suitable for mounting indoors and outdoors. Multiple cables should be separated by double troughs. We recommend the use of a counter-trough.



**St** Steel

**FT** Hot-dip galvanised

### Master data

Item number	1188201
Type	BS-F3-K-12 FT
Description 1	Clamp clip 2056
Description 2	triple
Manufacturer	OBO
Dimension	8-12mm
Material	Steel
Surface	Hot-dip galvanised
Surface standard	DIN EN ISO 1461
Smallest sales unit	50
Unit of quantity	Piece
Weight	5.218 kg
Weight unit	kg/100 pc.

# Technical data sheet

Clamp clip 2056, F foot, single, plastic pressure trough, FT



Item number: 1188201

## Dimensions

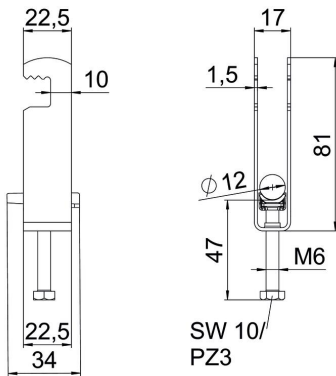

Length	22.5 mm
Width	17 mm
Height	81 mm
Plate thickness	1.5 mm
Dimension A	22.5 mm
Dimension B	17 mm
Dimension C	34 mm
Dimension G (mm)	M6
Dimension H	81 mm
Dimension L	47 mm
Dimension t	1.5 mm

## Technical data

Number of cables/pipes	3
For pipe diameter, max.	12 mm
For pipe diameter, min.	8 mm
Thread	M6
Halogen-free	yes
Length of external dimensions	34 mm
Max. Tightening torque	3 Nm
With plastic trough	yes
Mounting type	Flat profile
Slot width	10 mm
Clamping range D, max.	12 mm
Clamping range D, min.	8 mm
Surface addition	hot galvanised
Material addition	Steel